

Cartridge cavity CS16, CM16, CD16

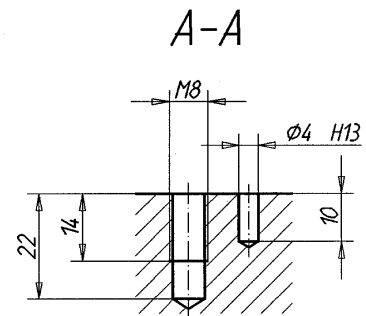
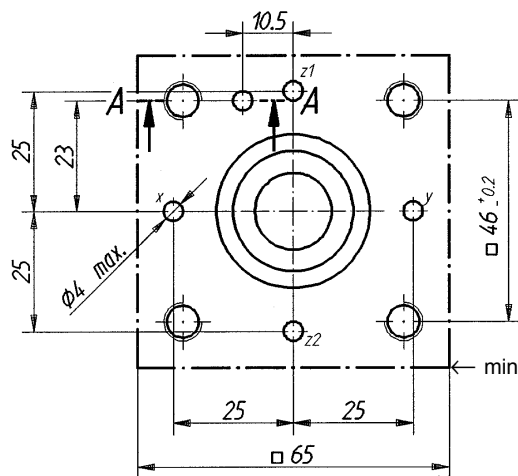
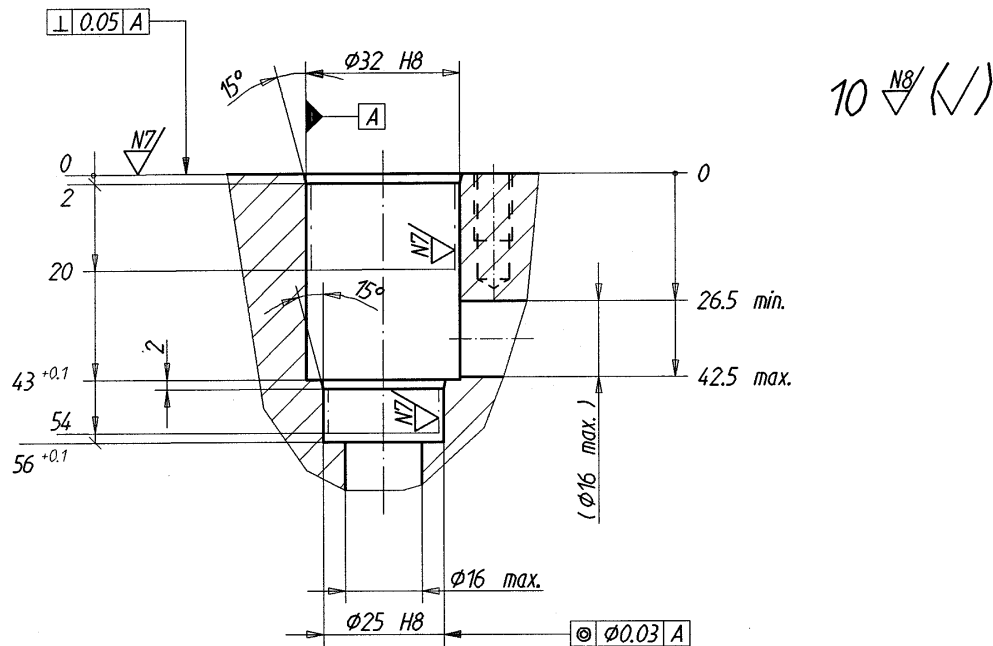

min. mounting surface for lid

(Drawing no. 8-001.4)

Application

Cartridge type:
C.16-...

Data sheet number:
1.12-210

Cartridge type:

Data sheet number: