

Cavity for poppet valve cartridge NG6

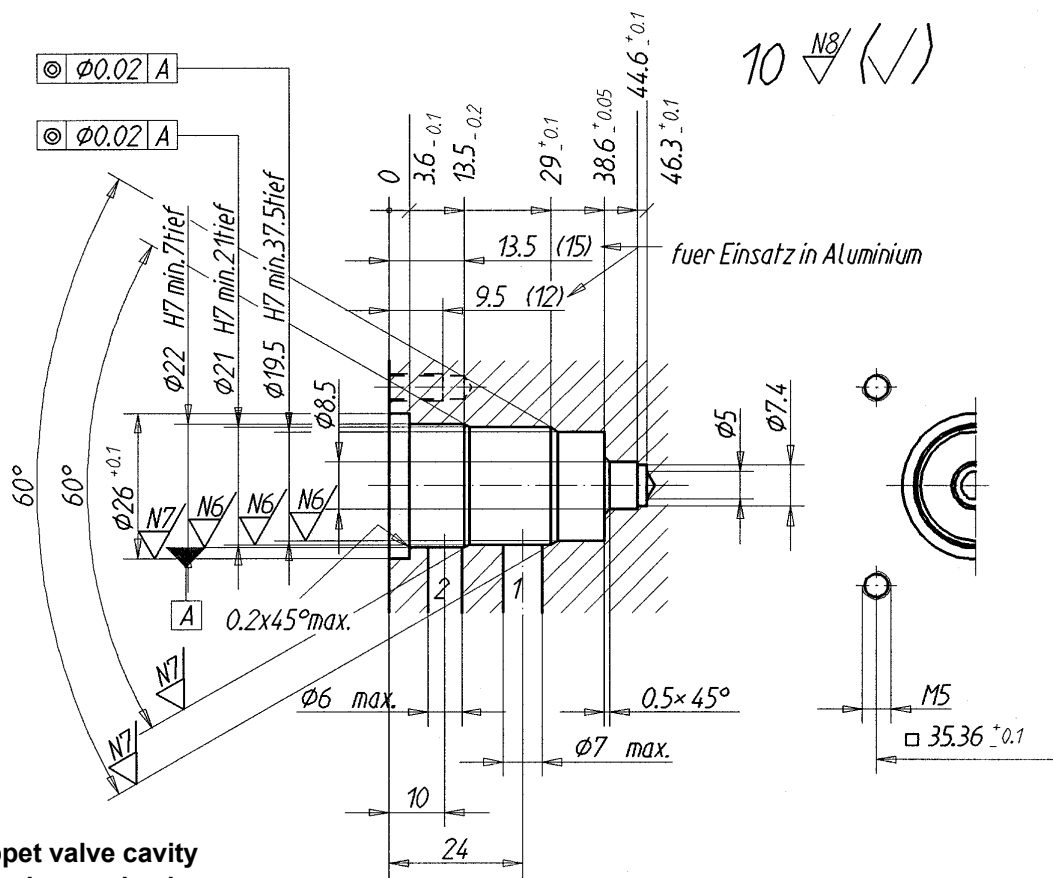

**2-way poppet valve cavity
open when deenergised**

(Drawing no. 5-2843.4)

Cavity tools

Denomination:

Form drill
Form reamer

Article number:

983.2106
983.2206

Form tool set

consisting of; form drill and form reamer

983.2804

Application

Cartridge type:

.22060-S1265-...

Data sheet number:

1.11-2035

Cartridge type:

Data sheet number: