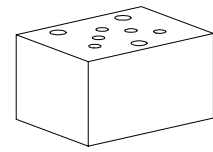

**Non-return valve
Sandwich construction**

- $Q_{max} = 20 \text{ l/min}$
- $p_{max} = 315 \text{ bar}$

NG4-Mini[®]

DESCRIPTION

Sandwich type pilot operated non-return valve NG4-Mini with interface according to Wandfluh standard. The valves allow a free flow in one direction and shut off in the opposite direction. 6 different standard versions are available. The steel sandwich body is phosphatised. Good performance data and attractive design are the hall marks of this quality product.

FUNCTION

In the free flow direction, the volume flow opens the spring loaded valve seat. The spring keeps the valve closed in the opposite direction. The opening pressure required depends on the spring force.

APPLICATION

Non-return valves allow the volume flow in one direction and shuts off in the opposite direction, preventing the pressurised fluid from flowing back. Non-return valves in the P port prevents backward rotation of the pump. When installed in the T port, the spring controlled opening pressure prevents a hydraulic system from draining to the tank. Sandwich type elements NG4-Mini make this a highly flexible system and save both weight and space.

CONTENT

GENERAL SPECIFICATIONS	1
HYDRAULIC SPECIFICATIONS	1
SYMBOLS / TYPES	1
CHARACTERISTICS	2
DIMENSIONS	2
PARTS LIST	2

TYPE CODE

	B	RV		4	#	
Interface						
Type description for non-return valve						
Non-return valve in:						
A and B	<input type="checkbox"/> AB	A	<input type="checkbox"/> A	B	<input type="checkbox"/> B	
P and T	<input type="checkbox"/> PT	P	<input type="checkbox"/> P	T	<input type="checkbox"/> T	
Nominal size 4-Mini						
Design-Index (Subject to change)						

GENERAL SPECIFICATIONS

Description	Non-return valve
Nominal size	NG4-Mini acc. to Wandfluh standard
Construction	Sandwich construction
Mounting	3 holes for hexagon socket screw M5 or studs M5
Connections	Connection plates Multi-station flange subplate Longitudinal stacking system
Ambient temperature	-20...+50°C
Mounting position	any
Fastening torque	$M_D = 5,5 \text{ Nm}$ (Quality 8.8)
Weight	$m = 0,46 \text{ kg}$

HYDRAULIC SPECIFICATIONS

Fluid	Mineral oil, other fluid on request
Contamination efficiency	ISO 4406:1999, class 20/18/14 (Required filtration grade $\beta_{10...16} \geq 75$) refer to data sheet 1.0-50/2
Viscosity range	12 mm ² /s...320 mm ² /s
Fluid temperature	-20...+70°C
Peak pressure	$p_{max} = 315 \text{ bar}$
Opening pressure	$p_o = 2,2 \text{ bar}$
Max. volume flow	$Q_{max} = 20 \text{ l/min}$

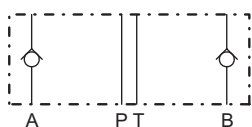
SYMBOLS / TYPES

BRVAB4

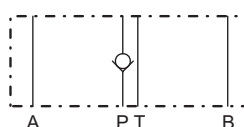

BRVP4



BRVA4

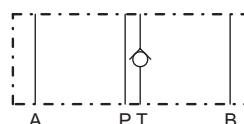

BRVT4

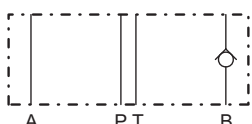

BRVB4

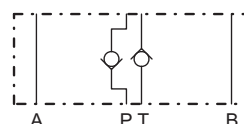

BRVPT4

CHARACTERISTICS Oil viscosity $\nu = 30 \text{ mm}^2/\text{s}$

$\Delta p = f(Q)$ Performance limit

Δp [bar]

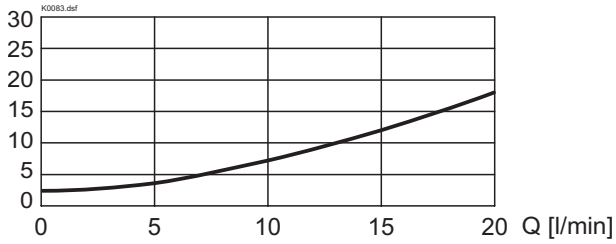

DIMENSIONS

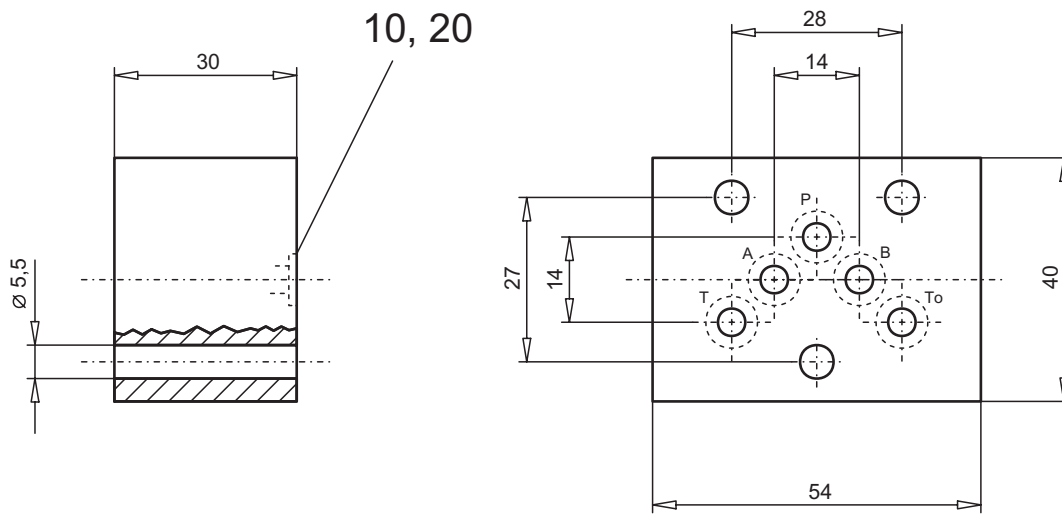

PARTS LIST

Position	Article	Description
10	160.2052	O-ring ID 5,28x1,78
20	160.2067	O-ring ID 6,75x1,78 (in A and B when RV in A, B or AB) (in T when RV in T)

Technical explanation see data sheet 1.0-100E