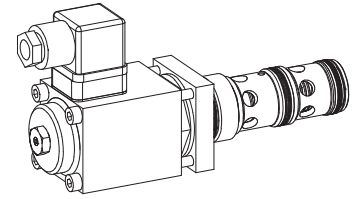

- Proportional 3-way flow control valve
- Screw-in cartridge
- Direct operated, pressure compensated
- $Q_{max} = 100 \text{ l/min}$, $p_{max} = 350 \text{ bar}$
- $Q_{Nmax} = 63 \text{ l/min}$

M33x2
 ISO 7789

DESCRIPTION

Direct operated, pressure compensated proportional flow control valve as a screw-in cartridge with a thread M33x2 for cavity acc. to ISO 7789. Two flow ranges are available. The volume flow is adjusted by a Wandfluh proportional solenoid (VDE standard 0580). Allmost linear flow increase and low hysteresis are typical for this valve. A special surface treatment guarantees a good protection against corrosion and wear as well as very good low-friction characteristics of the pressure compensating and throttle spools. The solenoid is zinc-coated.

FUNCTION

The 3-way flow control valve is designed to keep the oil flow to any actuator constant irrespective of the load. Surplus volume flow will be diverted to the tank line thus saving energy and preventing an overheating of the hydraulic system. The force controlled proportional solenoid running in the fluid acts directly on the control spool which opens the throttling notches in the cartridge body. The throttle opening, and therefore the flow volume changes proportionally to the current absorption of the proportional solenoid. When the solenoid is without current, the control spool is held in the closed position by a spring. To control the valve, proportional amplifiers are available from Wandfluh (see register 1.13).

APPLICATION

Proportional flow control valves are suitable for precise feed control system where the supply volume flow needs to be kept constant even when the load fluctuates. The screw-in cartridge is very suitable for mounting in control blocks, flange bodies and sandwich plates of the size NG10. Cavity tools are available for machining cartridge cavities (hire or purchase). Please refer to the data sheets in register 2.13.

CONTENTS

GENERAL SPECIFICATIONS.....	1
HYDRAULIC SPECIFICATIONS.....	1
ELECTRIC SPECIFICATIONS.....	1
SYMBOLS.....	1
CHARACTERISTICS.....	2
DIMENSIONS/ SECTIONAL DRAWINGS.....	2
PARTS LIST.....	2
ACCESSORIES.....	2

TYPE CODE

			Q	D	P	PM33	-		-		#		
Flow control valve													
3-way construction													
Proportional													
Screw-in cartridge M33x2													
Nominal volume flow rates Q_N :	32 l/min	<input type="text" value="32"/>											
	63 l/min	<input type="text" value="63"/>											
Standard nominal voltage U_N :	12 VDC	<input type="text" value="G12"/>											
	24 VDC	<input type="text" value="G24"/>											
Design-Index (Subject to change)													

GENERAL SPECIFICATIONS

Description	3-way proportional flow control valve
Construction	Screw-in cartridge for cavity acc. to ISO 7789
Operations	Proportional solenoid
Mounting	Screw-in thread M33x2
Ambient temperature	-20...50 °C
Mounting position	any
Fastening torque	$M_D = 80 \text{ Nm}$ for screw-in cartridge $M_D = 5,2 \text{ Nm}$ (Qual. 8.8) for solenoid screws
Weight	$m = 1,3 \text{ kg}$
Flow direction	see symbol

HYDRAULIC SPECIFICATIONS

Fluid	Mineral oil, other fluid on request
Contamination efficiency	ISO 4406:1999, class 18/16/13 (Required filtration grade $\beta_{6...10} \geq 75$) see data sheet 1.0-50/2
Viscosity range	12 mm ² /s...320 mm ² /s
Fluid temperature	-20...+70 °C
Peak pressure	$p_{max} = 350 \text{ bar}$
Nominal volume flow rates	$Q_N = 32 \text{ l/min}$, 63 l/min
Max. volume flow	$Q_{max} = 100 \text{ l/min}$ (1 → 2)
Min. volume flow	$Q_{min} = 0,2 \text{ l/min}$
Hysteresis	$\leq 5 \%$ * * at optimal dither signal

ELECTRICAL SPECIFICATIONS

Construction	Proportional solenoid, wet pin push type, pressure tight	
Standard nominal voltage	$U = 12 \text{ VDC}$	$U = 24 \text{ VDC}$
Limiting current	$I_G = 1780 \text{ mA}$	$I_G = 810 \text{ mA}$
Relative duty factor	100 % ED (see data sheet 1.1-430)	
Protection class	IP 65 acc. to EN 60 529	
Connection/	Over device plug connection to	
Power supply	ISO 4400 / DIN 43650, (2P+E)	
Other electrical specifications	see data sheet 1.1-130 (PI45V)	

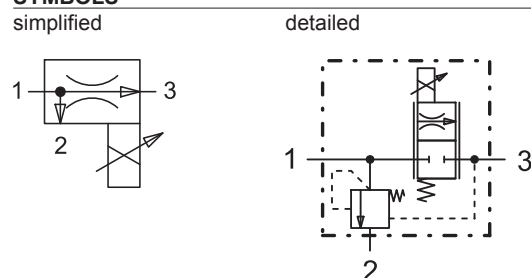
SYMBOLS

CHARACTERISTICS Oil viscosity $\nu = 30 \text{ mm}^2/\text{s}$
 $Q = f(I)$ Volume flow adjustment characteristics 1 → 3

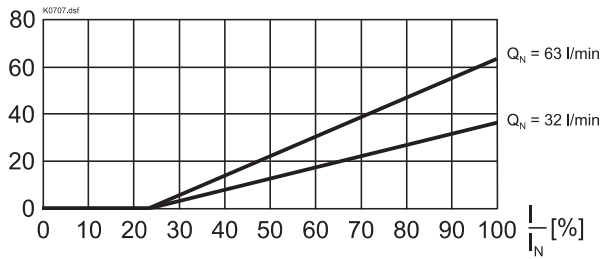
 Q [l/min]

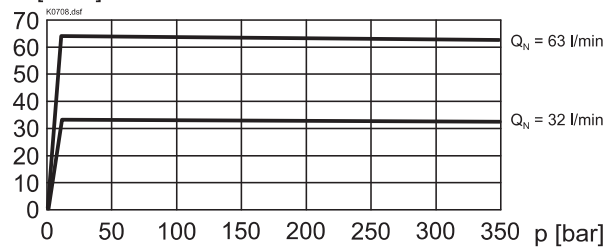
 $Q = f(p)$ Volume flow pressure characteristics

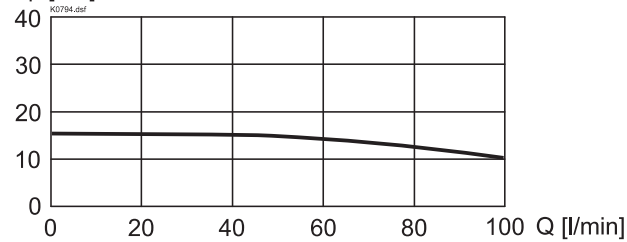
 Q [l/min]

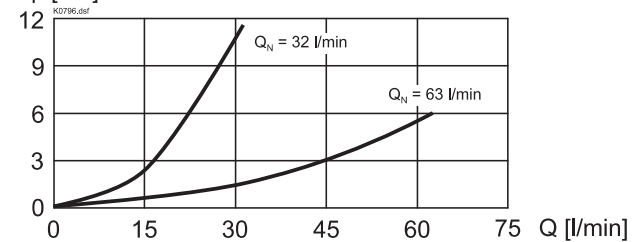
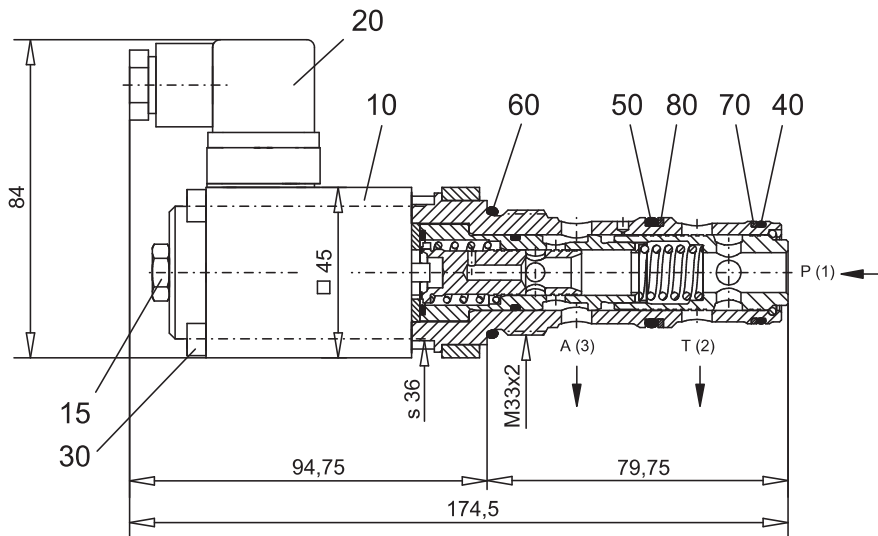
 $\Delta p = f(Q)$ Pressure drop volume flow characteristics 1 → 2

 Δp [bar]

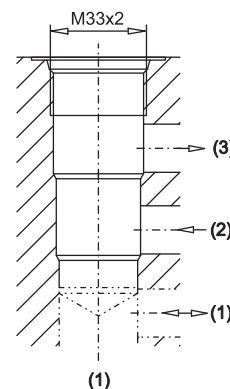
 $\Delta p = f(Q)$ Pressure drop volume flow characteristics 1 → 3

 Δp [bar]

DIMENSIONS / SECTIONAL DRAWINGS

Cavity drawing acc. to ISO 7789-33-04-0-98



For detailed cavity drawing and cavity tools see data sheet 2.13-1040

PARTS LIST

Position	Article	Description
10	256.4454	Proportional solenoid PI45V-G24
15	253.8001	Plug with integrated manual override HB6
20	219.2002	Plug (black)
30	246.2171	Socket head cap screw M5x70 DIN 912
40	160.2236	O-ring ID 23,52x1,78
50	160.2238	O-ring ID 23,81x2,62
60	160.2298	O-ring ID 29,82x2,62
70	049.3276	Back-up ring RD 24,1x27x1,4
80	049.3297	Back-up ring RD 24,5x29x1,4

ACCESSORIES

Proportional amplifier

register 1.13

Technical explanation see data sheet 1.0-100E