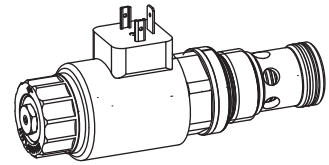

**Proportional 2-way flow control valve  
Screw-in cartridge**

- Direct operated, pressure compensated
- $Q_{max} = 80 \text{ l/min}$ ,  $p_{max} = 350 \text{ bar}$
- $Q_{Nmax} = 80 \text{ l/min}$

**M33 x 2**  
 ISO 7789

**DESCRIPTION**

Direct operated, pressure compensated proportional flow control valve, as a screw-in cartridge with a thread M33x2 for cavity acc. to ISO 7789. Three flow ranges are available. The volume flow is adjusted by a Wandfluh proportional solenoid (VDE standard 0580). Allmost linear flow increase and low hysteresis are typical for this valve. The cartridge body made of steel is special surface coated for corrosion rust protection and low friction of control- and throttle spools. The solenoid coil is zinc-/nickel-coated.

**FUNCTION**

The 2-way flow control valve is designed to keep the oil flow to any actuator constant irrespective of the load. The force controlled proportional solenoid running in the fluid acts directly on the restrictor spool which opens the throttling notches in the cartridge body. The throttle opening, and therefore the flow volume changes proportionally to the current absorption of the proportional solenoid. If pressure in the system changes the pressure compensator will change the area of the oil passage to an extend as to keep the pressure drop over the restrictor constant. When the solenoid is with-out current, the restrictor spool is held in the closed position by a spring. To control the valve Wandfluh proportional amplifiers are available (see register 1.13).

**APPLICATION**

Proportional flow control valves are suitable for precise feed control system where the supply volume flow needs to be kept constant even when the load fluctuates. The screw-in cartridge is very suitable for mounting in control blocks, flange bodys and sandwich plates size NG10. Stepped tools are available for making the receptacle bores in steel and aluminium (hire or purchase). Please refer to the data sheets in register 2.13.

**TYPE CODE**

		Q N P PM33 - <input type="checkbox"/> - <input type="checkbox"/> / <input type="checkbox"/> <input type="checkbox"/> - <input type="checkbox"/> <input type="checkbox"/> # <input type="checkbox"/>	
Flow control valve			
Normally closed			
Proportional			
Screw-in cartridge M33x2			
Nominal volume flow rates $Q_N$	32 l/min <input type="checkbox"/> 32	63 l/min <input type="checkbox"/> 63	80 l/min <input type="checkbox"/> 80
Standard nominal voltage $U_N$	12 VDC <input type="checkbox"/> G12	24 VDC <input type="checkbox"/> G24	without solenoid coil <input type="checkbox"/> X5
Slip-on coil	Metal housing, round <input type="checkbox"/> W	Metal housing, square <input type="checkbox"/> M*	
Electric connection	Connector socket EN 175301-803 / ISO 4400 <input type="checkbox"/> D	Connector socket AMP Junior-Timer <input type="checkbox"/> J	Connector Deutsch DT04-2P <input type="checkbox"/> G
Sealing material	NBR <input type="checkbox"/>	FKM (Viton) <input type="checkbox"/> D1	
Manual override	Armature tube closed (standard) <input type="checkbox"/>	With screwed sealing plug <input type="checkbox"/> HB0	With manual emergency actuation <input type="checkbox"/> HB4.5
Design-Index (Subject to change)			

\* Only available in conjunction with other nominal voltages and connection versions. (See data sheet 1.1-181)

**SYMBOLS**

simplified

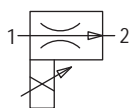

detailed

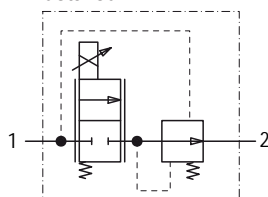
**GENERAL SPECIFICATIONS**

Description	2-way proportional flow control valve
Construction	Screw-in cartridge for cavity acc. to ISO 7789
Operations	Proportional solenoid
Mounting	Screw-in thread M33x2
Ambient temperature	-20...50 °C
Mounting position	any
Fastening torque	$M_D = 80 \text{ Nm}$ for screw-in cartridge $M_D = 7 \text{ Nm}$ for knurled nut
Weight	$m = 0,90 \text{ kg}$
Volume flow direction	1 → 2

**ELECTRICAL SPECIFICATIONS**

Construction	Proportional solenoid, wet pin push type, pressure tight	
Standard nominal voltage	U = 12 VDC	U = 24 VDC
Limiting current	I <sub>G</sub> = 1560 mA	I <sub>G</sub> = 780 mA
Relative duty factor	100% ED/DF (see data sheet 1.1-430)	
Protection class acc. to EN 60529	Connection version D: IP65 J: IP66 G: IP67 and 69K	
For further electrical specifications see data sheet	1.1-180 (W) 1.1-181 (M)	

**HYDRAULIC SPECIFICATIONS**

Fluid	Mineral oil, other fluid on request
Contamination efficiency	ISO 4406:1999, class 18/16/13 (Required filtration grade $\beta_{6...10} \geq 75$ ) refer to data sheet 1.0-50/2
Viscosity range	12 mm <sup>2</sup> /s...320 mm <sup>2</sup> /s
Fluid temperature	-20...+70 °C
Peak pressure	p <sub>max</sub> = 350 bar
Nominal volume flow rates	Q <sub>N</sub> = 32/63/80 l/min
Max. volume flow	Q <sub>max</sub> = 80 l/min
Min. volume flow	Q <sub>min</sub> = 0,2 l/min
Leakage volume flow	see characteristics
Repeatability	≤ 2%*
Hysteresis	≤ 5%*
	* at optimal dither signal

**CHARACTERISTICS** Oil viscosity  $\nu = 30 \text{ mm}^2/\text{s}$ 

Q = f (I) Volume flow adjustment characteristics

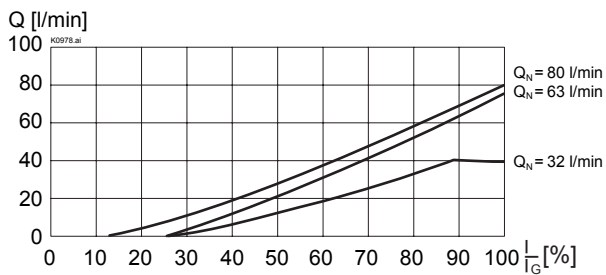

Q = f (p) Volume flow pressure characteristics

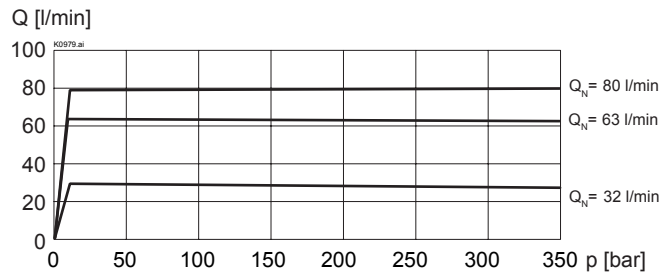
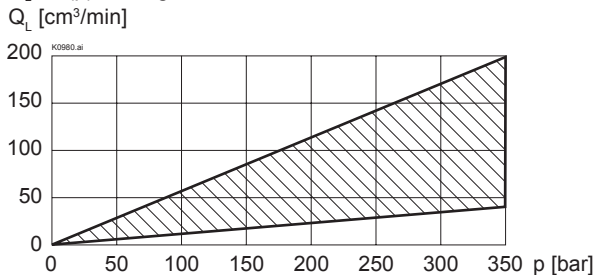
 Q<sub>L</sub> = f (p) Leakage volume flow characteristics

## DIMENSIONS / SECTIONAL DRAWINGS

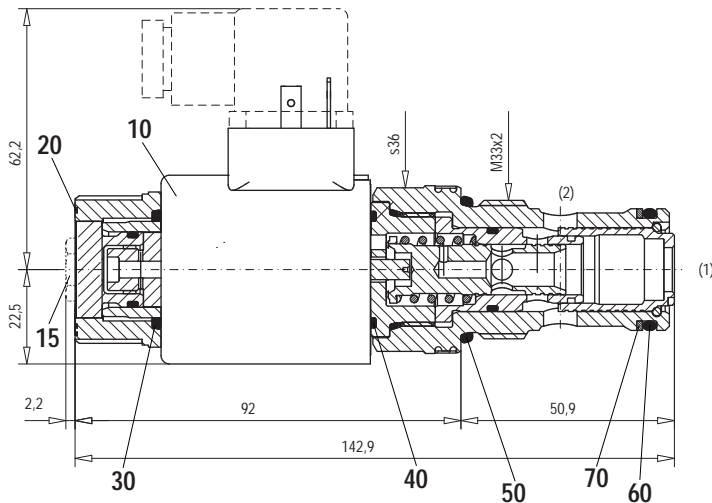
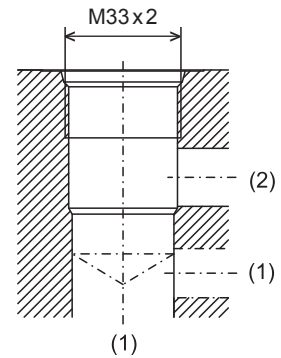
 Cavity drawing according to  
 ISO 7789-33-01-0-98

 For detailed cavity drawing  
 and cavity tools see data sheet 2.13-1005

## PARTS LIST

Position	Article	Description
10	206.1200	EN 175301 Solenoid coil WD45/23x50-G24
	206.1203	Solenoid coil WD45/23x50-G12
		Junior-Timer
	206.1201	Solenoid coil WJ45/23x50-G24
	206.1204	Solenoid coil WJ45/23x50-G12
		Deutsch
15	206.1202	Solenoid coil WG45/23x50-G24
	206.1205	Solenoid coil WG45/23x50-G12
15	253.8000	HB 4,5 Manual override (data sheet 1.1-300)
	239.2033	HB 0 Plug screw (data sheet 1.1-300)
20	154.2701	Knurled nut
30	160.2222	O-ring ID 22,22x2,62 (NBR)
	160.6222	O-ring ID 22,22x2,62 (FKM)
40	160.6218	O-ring ID 21,95 x 1,78 (FKM)
50	160.2298	O-ring ID 29,82x2,62 (NBR)
	160.6296	O-ring ID 29,82x2,62 (FKM)
60	160.2238	O-ring ID 23,81x2,62 (NBR)
	160.6238	O-ring ID 23,81x2,62 (FKM)
70	049.3297	Back up ring RD 24,5x29x1,4

## ACCESSORIES

Flange-/sandwich plate	Register 2.6
Line mount body	Data sheet 2.9-205
Proportional amplifier	Register 1.13
Mating connector EN 175301-803	Article no. 219.2002

Technical explanation see data sheet 1.0-100