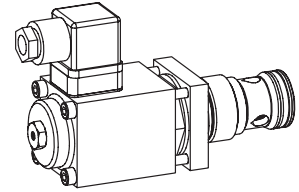

**Proportional throttle valve
Screw-in cartridge**

- Direct operated, not pressure compensated
- Throttle in one flow direction
- $Q_{max} = 65 \text{ l/min}$, $p_{max} = 250 \text{ bar}$
- $Q_{Nmax} = 63 \text{ l/min}$

M33x2
 ISO 7789

DESCRIPTION

Direct operated proportional throttle valve. Thread M33x2 and cavity in accordance with ISO 7789. Two flow ranges are available. The volume flow is adjusted by a Wandfluh proportional solenoid (VDE standard 0580). Progressive increase and decrease of volume flow and reduced hysteresis are characteristics of this valve. The cartridge body is made of steel. Its special surface coating protects the outside against corrosion and reduces friction of the control spool. The solenoid is zinc coated.

FUNCTION

The force controlled proportional solenoid running in the fluid acts directly on the control spool which opens or closes the triangular shaped throttling notches in the cartridge body. The throttle opening, and therefore the flow volume, changes proportionally to the current absorption of the proportional solenoid. When the solenoid is without current, the control spool is held in the closed position by a spring. To control the valve proportional amplifiers are available from Wandfluh (see register 1.13).

APPLICATION

Proportional throttle valves are suitable for precise feed control systems. Very sensitive opening and closing characteristics allow smooth control of movements in stationary or mobile installations, e.g. machine tools, public vehicles. Installation of the screw-in cartridge in control blocks as well as in the Wandfluh sandwich plates (vertical stacked systems) and flange valves of the NG10 size. (Please note the separate data sheets in register 2.6). Cavity tools are available for machining the cavities in steel and aluminium (hire or purchase). Please refer to the data sheets in register 2.13.

CONTENT

GENERAL SPECIFICATIONS	1
HYDRAULIC SPECIFICATIONS	1
ELECTRICAL SPECIFICATIONS	1
SYMBOL	1
CHARACTERISTICS	2
DIMENSIONS/ SECTIONAL DRAWINGS	2
PARTS LIST	2
ACCESSORIES	2

TYPE CODE

	D	N	P	PM33 -		-		#	
Throttle valve									
Normally closed									
Proportional									
Screw-in cartridge M33x2									
Nominal volume flow rates:									
	$Q_N = 63 \text{ l/min}$								
	$Q_N = 32 \text{ l/min}$								
Standard nominal voltage:									
	$U_N = 12 \text{ VDC}$								
	$U_N = 24 \text{ VDC}$								
Design-Index (Subject to change)									

GENERAL SPECIFICATIONS

Description	Direct operated proportional throttle valve
Construction	Screw-in cavity acc. to ISO 7789
Operations	Proportional solenoid
Mounting	Screw-in thread M33x2
Ambient temperature	-20...50 °C
Mounting position	any
Fastening torque	$M_D = 80 \text{ Nm}$ for screw-in cartridge $M_D = 5,2 \text{ Nm}$ (Qual. 8.8) for solenoid screws
Weight	$m = 1,2 \text{ kg}$
Volume flow direction	1 → 2

HYDRAULIC SPECIFICATIONS

Fluid	Mineral oil, other fluid on request
Contamination efficiency	ISO 4406:1999, class 18/16/13 (Required filtration grade $\beta_{6...10} \geq 75$) refer to data sheet 1.0-50/2
Viscosity range	12 mm ² /s...320 mm ² /s
Fluid temperature	-20...+70 °C
Peak pressure	$p_{max} = 250 \text{ bar}$
Nominal volume flow rates	$Q_N = 63 \text{ l/min}$, $Q_N = 32 \text{ l/min}$
Max. volume flow	$Q_{max} = 65 \text{ l/min}$
Leakage volume flow	on request
Hysteresis	≤ 8 % *
	* at optimal dithersignal

ELECTRICAL SPECIFICATIONS

Construction	Proportional solenoid, wet pin push type, pressure tight	
Standard nominal voltage	$U_N = 12 \text{ VDC}$	$U_N = 24 \text{ VDC}$
Limiting current	$I_G = 1780 \text{ mA}$	$I_G = 810 \text{ mA}$
Relative duty factor	100 % DF (see data sheet 1.1-430)	
Protection class	IP 65 acc. to EN 60 529	
Connection/Power supply	Over device plug connection to ISO 4400 / DIN 43 650 (2P+E)	
Other electrical specifications	see data sheet 1.1-135 (PI45V-M40)	

SYMBOL

„normally closed“

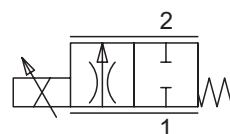

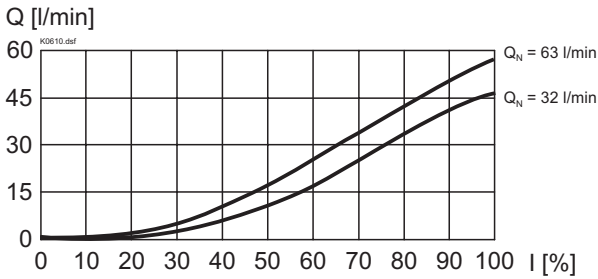
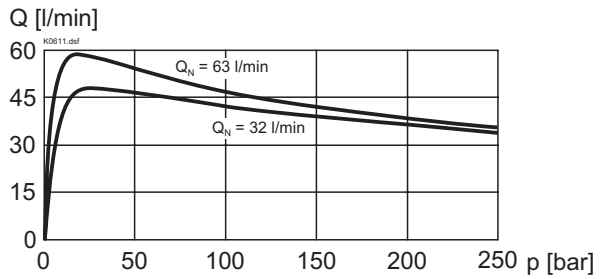
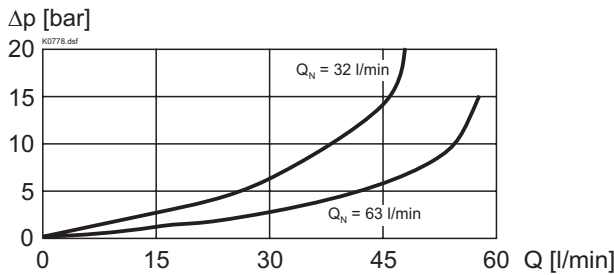
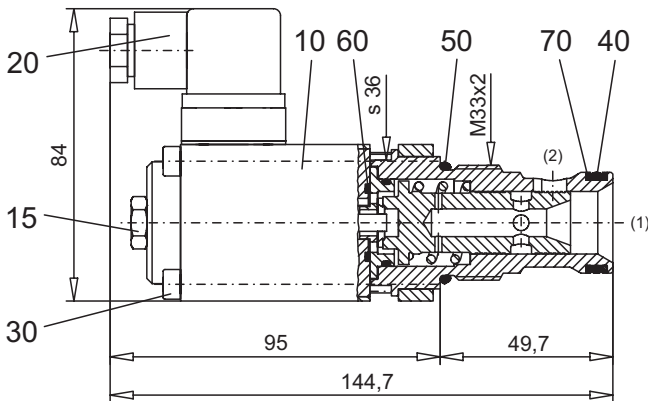
CHARACTERISTICS Oil viscosity $\nu = 30 \text{ mm}^2/\text{s}$
 $Q = f(l)$ Volume flow adjustment characteristics ($\Delta p = 20 \text{ bar}$)

 $Q = f(p)$ Volume flow pressure characteristics ($l = l_0$)

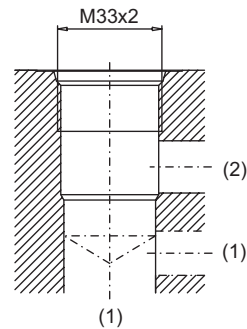
 $\Delta p = f(Q)$ Pressure drop volume flow characteristics ($l = l_0$)

DIMENSIONS / SECTIONAL DRAWINGS

Cavity drawing according to ISO 7789-33-01-0-98



For detailed cavity drawing and cavity tools see data sheet 2.13-1005.

PARTS LIST

Position	Article	Description
10	256.4465 256.4420	Proportional solenoid PI45V-G24-M40 Proportional solenoid PI45V-G12-M40
15	253.8001	Mounted screw with integrated manual override HB6
20	219.2002	Plug (black)
30	246.2171	Socket head cap screw M5x70 DIN 912
40	160.2238	O-ring ID 23,81x2,62
50	160.2298	O-ring ID 29,82x2,62
60	160.2188	O-ring ID 18,77x1,78
70	049.3297	Back up ring RD 24,5x29x1,4

ACCESSORIES

Cartridge built-in in flange- or sandwich body	
Flange-/sandwich plate	register 2.6
Proportional amplifier	register 1.13

Technical explanation see data sheet 1.0-100E