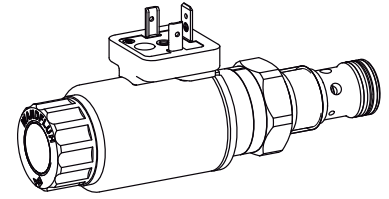

**Proportional throttle valve**
**Screw-in cartridge**

- Direct operated, not pressure compensated
- Throttle in one flow direction
- $Q_{\max} = 32 \text{ l/min}$ ,  $p_{\max} = 350 \text{ bar}$
- $Q_{N\max} = 25 \text{ l/min}$

**M22x1,5**  
 ISO 7789

**DESCRIPTION**

Direct operated proportional throttle valve with thread M22x1,5 and cavity in accordance with ISO 7789. Three nominal flow rates are available. The volume flow is adjusted by a Wandfluh proportional solenoid (VDE standard 0580). Progressive increase and decrease of volume flow and reduced hysteresis are characteristics of this valve. The cartridge body is made of steel. Its special surface coating protects the outside against corrosion and reduces friction of the control spool. The solenoid coil is zinc-/nickel-coated.

**FUNCTION**

The force controlled wet pin proportional solenoid acts directly on the control spool which opens, resp., closes the openings on the cartridge body. The throttle opening, and therefore the flow volume, changes proportionally to the current absorption of the proportional solenoid. When the solenoid is without current, the control spool is held in the closed position by a spring. To control the valve proportional amplifiers are available from Wandfluh (see register 1.13).

**APPLICATION**

Proportional throttle valves are suitable for precise feed control systems. Very sensitive opening and closing characteristics allow smooth control of movements in stationary or mobile installations, e.g. machine tools, public vehicles. Installation of the screw-in cartridge in control blocks as well as in the Wandfluh sandwich plates (vertical stacked systems) and flange valves of the NG4-Mini and NG6 types. size. (Please note the separate data sheets in register 2.6). Cavity tools are available for machining the cavities in steel and aluminium (hire or purchase). Please refer to the data sheets in register 2.13.

**TYPE CODE**

		D N P PM22 - <input type="checkbox"/> - <input type="checkbox"/> / <input type="checkbox"/> <input type="checkbox"/> - <input type="checkbox"/> <input type="checkbox"/> # <input type="checkbox"/>	
Throttle valve			
Normally closed			
Proportional			
Screw-in cartridge M22x1,5			
Nominal volume flow rates	$Q_N = 6,3 \text{ l/min}$ $Q_N = 10 \text{ l/min}$ $Q_N = 25 \text{ l/min}$	<input type="checkbox"/> 6,3 <input type="checkbox"/> 10 <input type="checkbox"/> 25	
Standard nominal voltage $U_N$	12 VDC 24 VDC without solenoid coil	<input type="checkbox"/> G12 <input type="checkbox"/> G24 <input type="checkbox"/> X5	
Slip-on coil	Metal housing, round Metal housing, square	<input type="checkbox"/> W <input type="checkbox"/> M*	
Electric connection	Connector socket EN 175301-803 / ISO 4400 Connector socket AMP Junior-Timer Connector Deutsch DT04-2P	<input type="checkbox"/> D <input type="checkbox"/> J <input type="checkbox"/> G	
Sealing material	NBR FKM (Viton)	<input type="checkbox"/> <input type="checkbox"/> D1	
Manual override	Armature tube closed (standard) With screwed sealing plug With manual emergency actuation	<input type="checkbox"/> <input type="checkbox"/> HB0 <input type="checkbox"/> HB4.5	
Design-Index (Subject to change)			

\* Only available in conjunction with other nominal voltages and connection versions. (See data sheet 1.1-173)

**SYMBOL**

«normally closed»

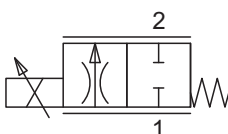
**GENERAL SPECIFICATIONS**

Description	Direct operated proportional throttle valve
Construction	Screw-in cavity acc. to ISO 7789
Operation	Proportional solenoid
Mounting	Screw-in thread M22x1,5
Ambient temperature	-20...70 °C
Mounting position	any, preferably horizontal
Fastening torque	$M_D = 50 \text{ Nm}$ for screw-in cartridge $M_D = 5 \text{ Nm}$ for knurled nut
Weight	$m = 0,57 \text{ kg}$
Volume flow direction	1 → 2

**ELECTRICAL SPECIFICATIONS**

Construction	Proportional solenoid, wet pin push type, pressure tight	
Standard nominal voltage	U = 12 VDC	U = 24 VDC
Limiting current	I <sub>G</sub> = 1320 mA	I <sub>G</sub> = 660 mA
Relative duty factor	100 % ED/DF (see data sheet 1.1-430)	
Protection class acc. to EN 60 529	Connection version D: IP 65 J: IP 66 G: IP 67 and 69K	
For further electrical specifications see data sheet	1.1-173 (W) 1.1-174 (M)	

**HYDRAULIC SPECIFICATIONS**

Fluid	Mineral oil, other fluid on request
Contamination efficiency	ISO 4406:1999, class 18/16/13 (Required filtration grade $\beta_{6...10} \geq 75$ ) refer to data sheet 1.0-50/2
Viscosity range	12 mm <sup>2</sup> /s...320 mm <sup>2</sup> /s
Fluid temperature	-20...+70 °C
Peak pressure	p <sub>max</sub> = 350 bar
Nominal volume flow rates	Q <sub>N</sub> = 6,3 l/min, 10 l/min, 25 l/min at 10 bar pressure drop and I <sub>G</sub>
Max. volume flow	Q <sub>max</sub> = 32 l/min
Leakage volume flow	on request
Hysteresis	≤ 5%* * at optimal dither signal

**CHARACTERISTICS** Oil viscosity  $\nu = 30 \text{ mm}^2/\text{s}$ 

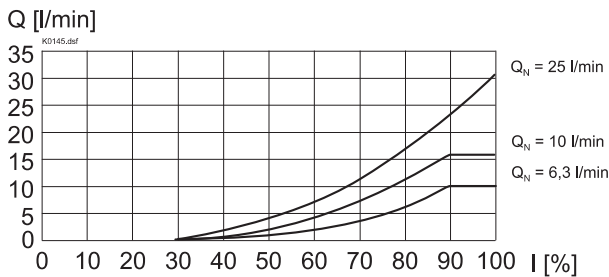
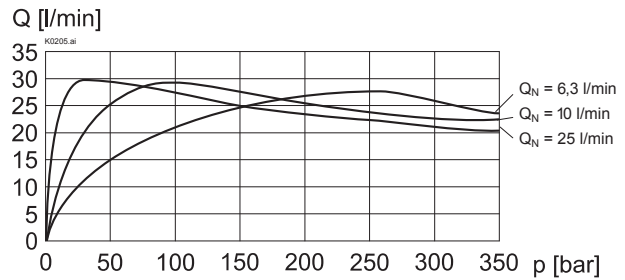
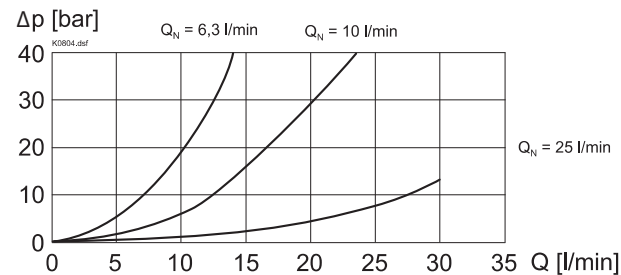
 Q = f (I) Volume flow adjustment characteristics ( $\Delta p = 20 \text{ bar}$ )

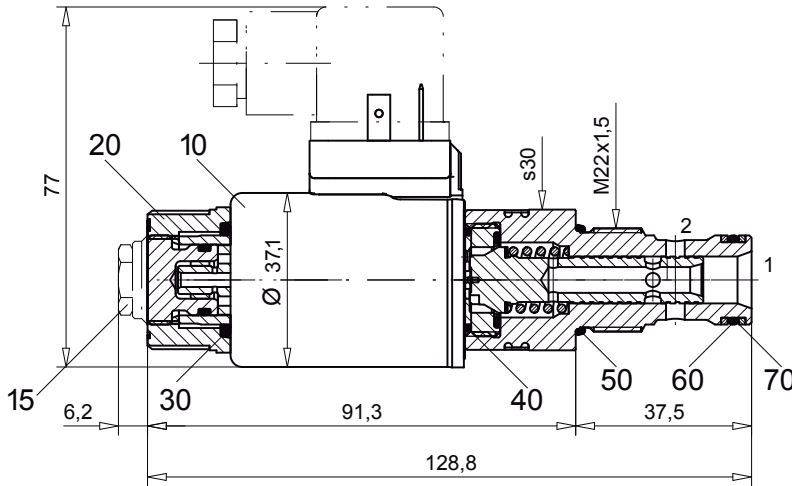
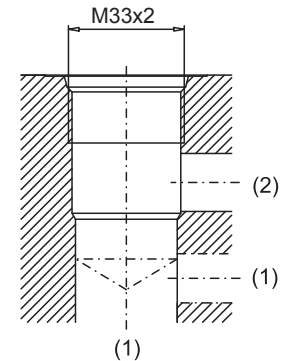
 Q = f (p) Volume flow pressure characteristics (I = I<sub>G</sub>)

 $\Delta p = f(Q)$  Pressure drop volume flow characteristics (I = I<sub>G</sub>)

**DIMENSIONS / SECTIONAL DRAWINGS**

 Cavity drawing according to  
 ISO 7789-22-01-0-98

 For detailed cavity drawing  
 and cavity tools see data sheet 2.13-1008

Dimensions of the other connection versions see data sheet 1.1-173

**PARTS LIST**

Position	Article	Description
10	206.2201	EN 175301 Solenoid coil WD37/19x50-G24
	206.2200	Solenoid coil WD37/19x50-G12 Junior-Timer
	206.2203	Solenoid coil WJ37/19x50-G24
	206.2202	Solenoid coil WJ37/19x50-G12
	206.2205	Deutsch Solenoid coil WG37/19x50-G24
	206.2204	Solenoid coil WG37/19x50-G12
15	253.8000	HB 4,5 Manual override (data sheet 1.1-300)
	239.2033	HB 0 Plug screw (data sheet 1.1-300)
20	154.2700	Knurled nut
30	160.2187	O-ring ID 18,72x2,62 (NBR)
	160.6187	O-ring ID 18,72x2,62 (FKM)
40	160.2170	O-ring ID 17,17x1,78 (NBR)
	160.6172	O-ring ID 17,17x1,78 (FKM)
50	160.2188	O-ring ID 18,77x1,78 (NBR)
	160.6188	O-ring ID 18,77x1,78 (FKM)
60	160.2156	O-ring ID 15,60x1,78 (NBR)
	160.6156	O-ring ID 15,60x1,78 (FKM)
70	049.3196	Back up ring RD 16,1x19x1,4

**ACCESSORIES**

Flange-/sandwich plate	Register 2.6
Line mount body	Data sheet 2.9-205
Proportional amplifier	Register 1.13
Mating connector EN 175301-803	Article no. 219.2002

Technical explanation see data sheet 1.0-100