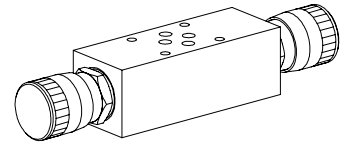

Restrictor valve with reverse free flow check
Sandwich construction

- $Q_{max} = 70 \text{ l/min}$
- $Q_N = 40 \text{ l/min}$
- $p_{max} = 350 \text{ bar}$

NG6
ISO 4401-03

DESCRIPTION

Restrictor valve sandwich type NG6 with interface to ISO 4401-03. The non-return throttle valve is available in two different variants, namely the standard and the precision throttle (FD). The turning knob is made from aluminium, all other parts made of steel, have been phosphated.

FUNCTION

Using the precision thread adjusting spindle, the restriction of the volume flow can be continuously adjusted. With the spindle fully screwed home, the volume flow is zero, and a metallic edge makes a leak-tight closure. In the opposite direction, the spring-loaded tapered piston opens and volume flow with a load pressure drop is enabled. The throttle effect is produced by an annular gap which can be varied in size, or by means of a triangular edge. Because of the nature of the design, there is only a small amount of leakage.

APPLICATION

Sandwich type, one-way restrictors are used where volume flows have to be controlled in one flow direction according to the load. Depending on the application, a distinction is made between restricting the forward flow or the return flow. These sandwich valves are particularly suitable for machine tools and also all kinds of handling operations.

CONTENTS

GENERAL SPECIFICATIONS	1
HYDRAULIC SPECIFICATIONS	1
TYPE LIST / FUNCTION	1
CHARACTERISTICS	2
DIMENSIONS	2
PARTS LIST	2

TYPE CODE

	A	URD	6	-	#	
International mounting interface ISO						
Description for restrictor valve						
Meter out in:						
A <input type="checkbox"/> A		B <input type="checkbox"/> B				
A and B no remark						
Meter-in in:						
A <input type="checkbox"/> VA		B <input type="checkbox"/> VB				
A and B <input type="checkbox"/> V						
Nominal size 6						
Additional marking for precision throttle <input type="checkbox"/> FD						
Design-Index (Subject to change)						

GENERAL SPECIFICATIONS

Denomination	Restrictor valve with reverse free flow check
Nominal size	NG6 acc. to ISO 4401-03
Construction	Sandwich
Mounting	4 mounting holes for socket head cap screws M5 or stud screws M5
Connections	Threaded connection plates, Multi-flange subplates, Longitudinal stacking system
Ambient temperature	-20...+50° C
Mounting position	any
Fastening torque	$M_D = 5,5 \text{ Nm}$ (Qual. 8.8) for fastening screws
Weight	Depending on the type 1,8...1,9 kg

HYDRAULIC SPECIFICATIONS

Fluid	Mineraoil, other fluid on request
Contamination efficiency	ISO 4406:1999, class 20/18/14...21/19/15 (Required filtration grade $\beta_{10...25} \geq 75$) refer to data sheet 1.0-50/2
Viscosity range	12 mm ² /s...320 mm ² /s
Fluid temperature	-20...+70° C
Peak pressure	$p_{max} = 350 \text{ bar}$
Pressure required to open the check valve	$p_o = 2 \text{ bar}$
Nominal volume flow rates	$Q_N = 40 \text{ l/min}$ Q_N at 10 bar valve pressure loss
Max. volume flow	$Q_{max} = 70 \text{ l/min}$
Leakage volume flow	Almost leak free with closed restrictor

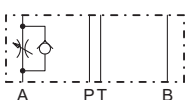
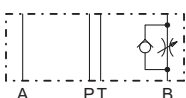
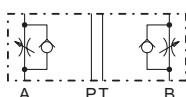
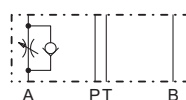
TYPE LIST / FUNCTION
Meter-out:

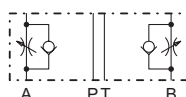
AURDA6

AURDB6

AURD6
Meter-in:

AURDVA6

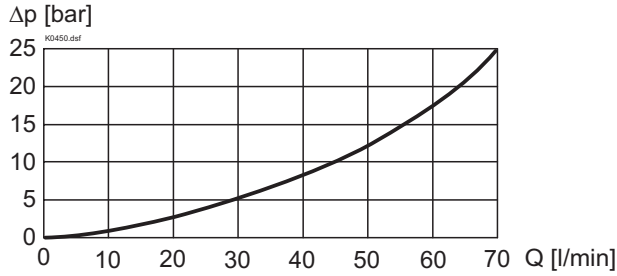
AURDVB6

AURDV6

Valves for restricting the meter-in flow are achieved by turning the meter-out valves restrictors (longitudinal axis):
 AURDA6 get AURDVA6
 AURDB6 get AURDVB6
 AURD6 get AURDV6
 Valves for restricting the meter-in flow are supplied with a sealing plate and an intermediate plate.

CHARACTERISTICS Oil viscosity $\nu = 30 \text{ mm}^2/\text{s}$

$\Delta p = f(Q)$ Pressure loss/flow characteristics



$\Delta p = f(Q)$ Pressure loss/flow characteristics over non-return valve

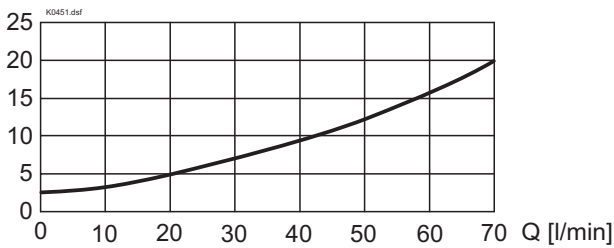

$Q = f(n)$ Volume flow adjustment characteristics (Standard)

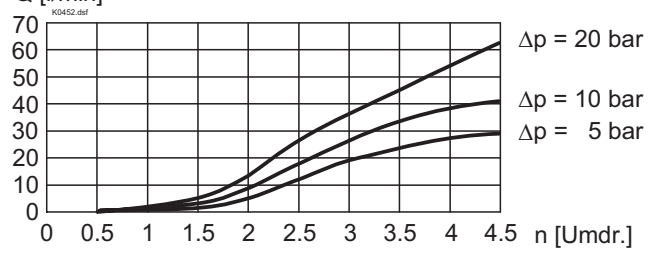

$Q = f(n)$ Volume flow adjustment characteristics (Precision throttle)

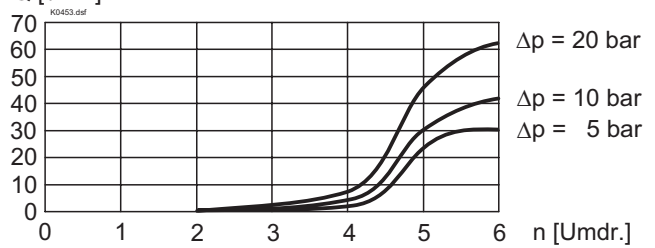

DIMENSIONS

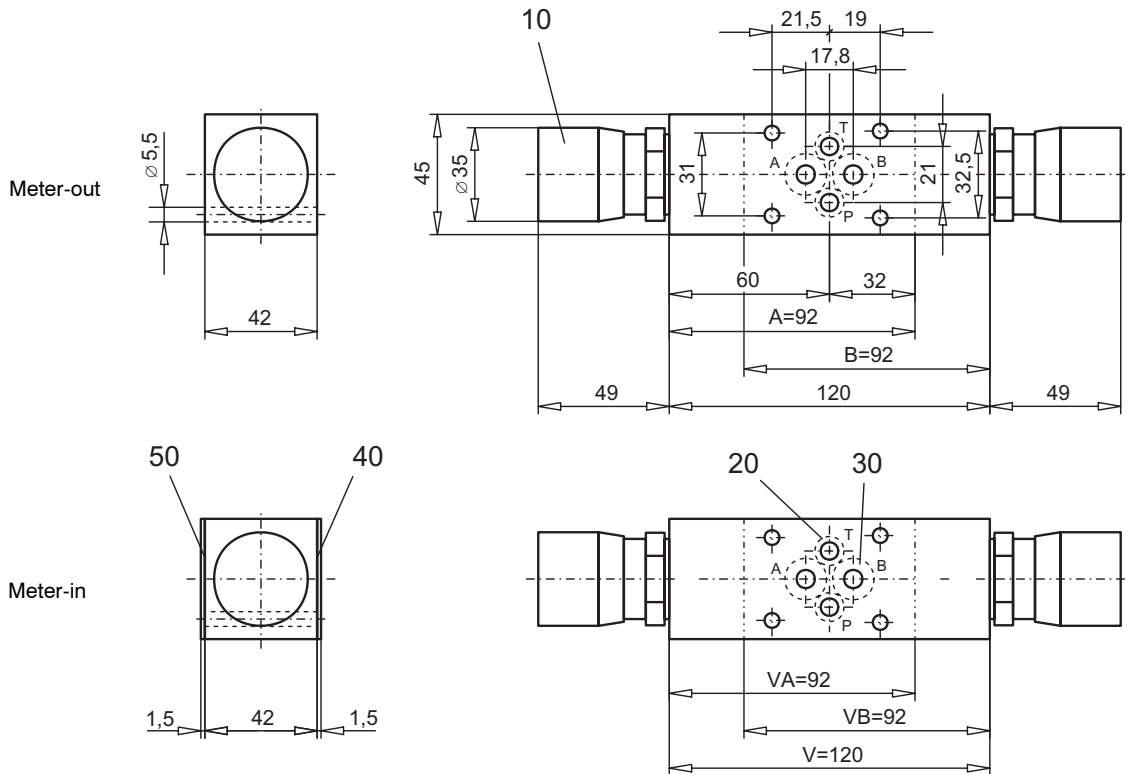

PARTS LISTS

Position	Article	Description
10	114.1201	Turning knob
20	160.2076	O-ring ID 7,65x1,78
30	160.2120	O-ring ID 12,42x1,78 in line with check valve
40	173.3650	Sealing plate ADB6
50	173.3700	Intermediate plate AZB6

Technical explanation see data sheet 1.0-100E