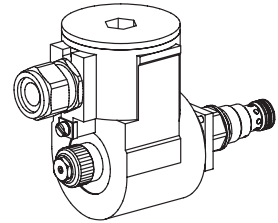

**Proportional pressure relief valve
Screw-in cartridge**

- Pilot operated
- $Q_{max} = 100$ l/min
- $p_{max} = 400$ bar
- $p_{Nmax} = 350$ bar

M22x1,5

ISO 7789

II 2 G
EEx d II C

DESCRIPTION

Pilot operated proportional pressure relief valve as a screw-in cartridge with a thread M22x1,5 for cavity according to ISO 7789. Activated with explosion proof solenoid. The cartridge body made of steel is galvanized and therefore rust-protected.

EEx: in accordance with European standards EN 50014, EN 50018

d: flameproof enclosure

Groupe II C: (gas group II A, II B) for all applications except mining

Zone 1: (and 2) explosive mixtures present intermittently

EC-type examination certificate:

Execution T4: PTB 98 ATEX 1009

Execution T6: PTB 98 ATEX 1008

CONTENT

GENERAL SPECIFICATIONS	1
HYDRAULIC SPECIFICATIONS	1
SYMBOL	1
ELECTRICAL SPECIFICATIONS	2
START-UP	2
CHARACTERISTICS	2
DIMENSIONS/ SECTIONAL DRAWING	2
PARTS LIST	2
ACCESSORIES	2

FUNCTION

When the operating pressure set by the proportional solenoid is reached, the main spool opens and connects the protected line with the return line to the tank. The back pressure in T (2) influences the pressure in P (1). This pilot operated proportional pressure relief valve can be adjusted very sensitively and is suitable for large volume flows and high pressures. To control the valve Wandfluh proportional amplifiers are available (see register 1.13).

APPLICATION

The valve has its application in hydraulic systems, in which the pressure frequently has to be changed. The facility for remote control and signal processing from process control systems enable elegant, comfortable solutions to problems. Installation of the screw-in cartridge in control blocks as well as in the Wandfluh sandwich plates (vertical stacked systems) and flange valves of the NG4-Mini, NG6 and NG10 types. (Please note the separate data sheets in register 2.3). Cavity tools are available for machining the cavities in steel and aluminium (hire or purchase). Please refer to the data sheets in register 2.13.

TYPE CODE

		B V B PM22 - <input type="checkbox"/> - G24 / <input type="checkbox"/> # <input type="checkbox"/>	
Pressure relief valve	<input type="checkbox"/>	<input type="checkbox"/>	<input type="checkbox"/>
Pilot operated	<input type="checkbox"/>	<input type="checkbox"/>	<input type="checkbox"/>
Proportional explosion proof, execution EExdIIC	<input type="checkbox"/>	<input type="checkbox"/>	<input type="checkbox"/>
Screw-in cartridge M22x1,5	<input type="checkbox"/>	<input type="checkbox"/>	<input type="checkbox"/>
Standard nominal pressure range:	$p_N = 20$ bar <input type="checkbox"/> 20 $p_N = 63$ bar <input type="checkbox"/> 63 $p_N = 100$ bar <input type="checkbox"/> 100 $p_N = 160$ bar <input type="checkbox"/> 160	$p_N = 200$ bar <input type="checkbox"/> 200 $p_N = 250$ bar <input type="checkbox"/> 250 $p_N = 350$ bar <input type="checkbox"/> 350	
Standard nominal voltage	$U_N = 24$ VDC	<input type="checkbox"/> G24	
Execution:	T1...T4 <input type="checkbox"/> T4	<input type="checkbox"/> T6 (on request)	
Design-Index (Subject to change)			

• Data sheet is valid from design-index #2 on

GENERAL SPECIFICATIONS

Description	Pilot operated proportional pressure relief valve
Construction	Screw-in cartridge for cavity according to ISO 7789
Operations	Proportional solenoid
Mounting	Screw-in thread M22x1,5
Admissible ambient temp. *:	
Execution T4	-20...+40 °C
Execution T6 (on request)	-20...+90 °C (operation as T1...T4) -20...+40 °C (operation as T5/T6)
Mounting position	any, preferably horizontal
Fastening torque	$M_D = 50$ Nm for screw-in cartridge
Weight	$m = 2,2$ kg

HYDRAULIC SPECIFICATIONS

Fluid	Mineral oil, other fluid on request
Contamination	ISO 4406:1999, class 18/16/13
efficiency	(Required filtration grade $\beta_{6...10} \geq 75$) see data sheet 1.0-50/2
Viscosity range	12 mm ² /s...320 mm ² /s
Admissible fluid temp. *:	(at inlet and at outlet)
Execution T4	-20...+40 °C
Execution T6 (on request)	-20...+70 °C (operation as T1...T4) -20...+40 °C (operation as T5/T6)
Peak pressure	$p_{max} = 400$ bar $p_{Tmax} = p_p + 20$ bar
Nominal pressure ranges	$p_N = 20$ bar, $p_N = 63$ bar $p_N = 100$ bar, $p_N = 160$ bar $p_N = 200$ bar, $p_N = 250$ bar $p_N = 350$ bar
Volume flow range	$Q = 0,3...100$ l/min
Leakage volume flow	see characteristics
Repeatability	$\leq 3\%$ **
Hysteresis	$\leq 4\%$ **
	** with optimal dither signal

* Deviating pressure medium - or ambient temperatures are possible for special arrangements after checking and authorisation by a responsible inspector. Measures for the prevention of the exceeding of the admissible solenoid surface - and internal temperatures can be: a good ventilation, low ambient temperatures (for higher pressure medium temperatures), limitation of the maximum possible power supply voltage, a short switching-on duration, installation on large heat dissipating blocks, etc. The responsibility in all cases lies with the operator, resp. with his inspector.

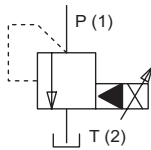
SYMBOL

ELECTRICAL SPECIFICATIONS

Construction	Proportional solenoid, wet pin push type, pressure tight
Standard nominal voltage	$U_N = 24$ VDC wired with VDR
Limiting current	T4: $I_G = 450$ mA T6: $I_G = 260$ mA (on request)
Relative duty factor	100% ED
Protection class	IP 65 acc. to EN 60 529
Connection/Power supply	Through cable entry for cable $\varnothing 11 \dots 14$ mm (acc. to EN 50014)
Temperature class:	
Execution T4	T1...T4
Execution T6	T1...T6 (on request)
Performance limit:	
Execution T4	11,7 W at $I_G = 450$ mA
Execution T6	6 W at $I_G = 260$ mA (on request)

START-UP

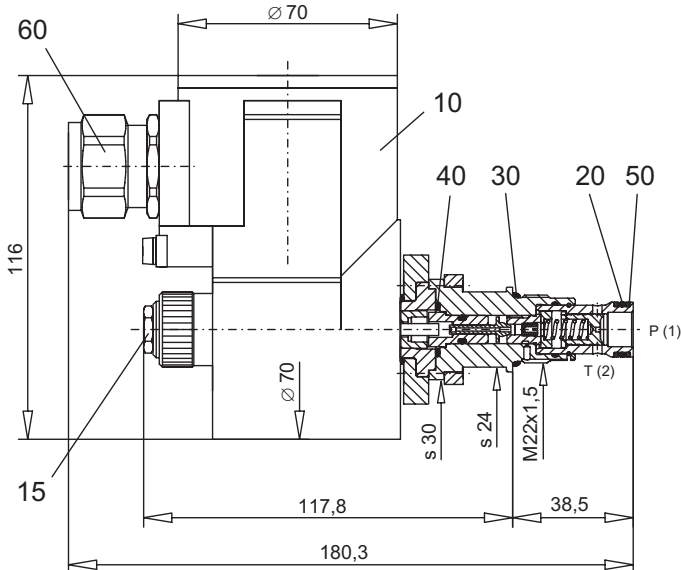
Information concerning the installation and commissioning is contained in the operating instructions supplied together with the solenoid coil.

DIMENSIONS / SECTIONAL DRAWING

PARTS LIST

Position	Article	Description
10	207.5293	Slip-on coil 2A67W EExd II C T4
15	253.8000	Plug with integrated manual override HB4,5
20	160.2140	O-ring ID 14,00x1,78
30	160.2188	O-ring ID 18,77x1,78
40	049.3177	Back-up ring RD 14,6x17,5x1,4
50	111.1080	Cable entry brass M20

CHARACTERISTICS (T6 on request)

 oil viscosity $\nu = 30$ mm²/s

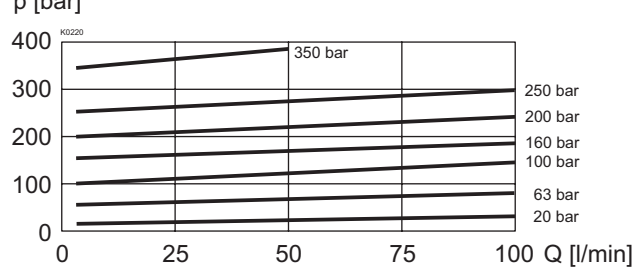
$p = f(Q)$ Pressure volume flow characteristics
(Maximum adjustable pressure)



$p = f(Q)$ Pressure volume flow characteristics
(Minimum adjustable pressure)

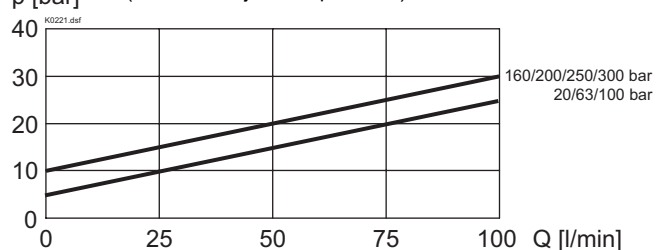

$p = f(I)$ Pressure signal characteristics
($Q = 10$ l/min)

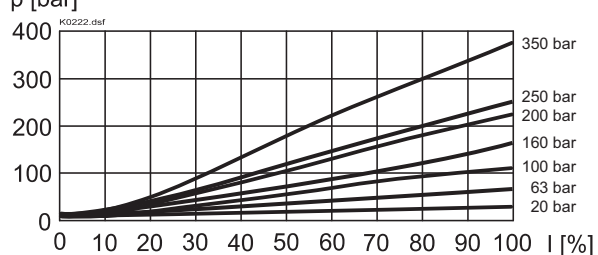

$Q_L = f(p)$ Leakage volume flow characteristics

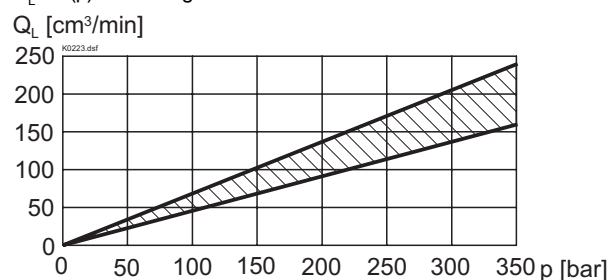
ACCESSORIES

Cartridge built into flange- or sandwich body

Flange body/sandwich plate

register 2.3

Proportional amplifier

register 1.13

Cavity drawing ISO 7789-22-02-0-98

and cavity tools see

data sheet 2.13-1003

Technical explanation see data sheet 1.0-100E