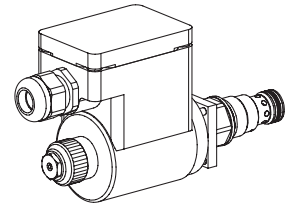

**Proportional pressure relief valve
Screw-in cartridge**

- Pilot operated
- $Q_{max} = 100$ l/min
- $p_{max} = 400$ bar
- $p_{Nmax} = 350$ bar

M22x1,5
 ISO 7789

DESCRIPTION

Pilot operated proportional pressure relief valve as a screw-in cartridge with a thread M22x1,5 for cavity according to ISO 7789. Activated with explosion proof solenoid. The cartridge body made of steel is zinc coated for corrosion protection.

EEx: in accordance with European standards EN 50014, EN 50019, EN 50028

e: increased safety

m: encapsulation

Group II:

for all applications except mining

Zone 1 / 21 (and 2 / 22):

explosive mixtures present intermittently

EC-type examination certificate:

PTB 01 ATEX 2129 X

FUNCTION

When the operating pressure set by the proportional solenoid is reached, the main spool opens and connects the protected line with the return line to the tank. The back pressure in T (2) influences the pressure in P (1). This pilot operated proportional pressure relief valve can be adjusted very sensitively and is suitable for large volume flows and high pressures. To control the valve Wandfluh proportional amplifiers are available (see register 1.13).

APPLICATION

The valve has its application in hydraulic systems, in which the pressure frequently has to be changed. The facility for remote control and signal processing from process control systems enable elegant, comfortable solutions to problems. Installation of the screw-in cartridge in control blocks as well as in the Wandfluh sandwich plates (vertical stacked systems) and flange valves of the NG4-Mini, NG6 and NG10 types. (Please note the separate data sheets in register 2.3). Cavity tools are available for machining the cavities in steel and aluminium (hire or purchase). Please refer to the data sheets in register 2.13.

CONTENT

GENERAL SPECIFICATIONS	1
HYDRAULIC SPECIFICATIONS	1
SYMBOL	1
ELECTRICAL SPECIFICATIONS	2
START-UP	2
CHARACTERISTICS	2
DIMENSIONS/	
SECTIONAL DRAWINGS	2
PARTS LIST	2
ACCESSORIES	2

TYPE CODE

Pressure relief valve		B	V	C	PM22	-	<input type="text"/>	-	G24	/	T4	#	<input type="text"/>	
Pilot operated														
Proportional explosion proof, execution EExemII														
Screw-in cartridge M22x1,5														
Standard nominal pressure ranges:	$p_N = 20$ bar	<input type="text" value="20"/>	$p_N = 200$ bar	<input type="text" value="200"/>	$p_N = 63$ bar	<input type="text" value="63"/>	$p_N = 250$ bar	<input type="text" value="250"/>	$p_N = 100$ bar	<input type="text" value="100"/>	$p_N = 350$ bar	<input type="text" value="350"/>	$p_N = 160$ bar	<input type="text" value="160"/>
Standard nominal voltage:	$U_N = 24$ VDC													
Execution T1...T4														
Design-Index (Subject to change)														

• Data sheet is valid from design-index # 2 on

GENERAL SPECIFICATIONS

Description	Pilot operated proportional pressure relief valve
Construction	Screw-in cartridge for cavity to ISO 7789
Operations	Proportional solenoid
Mounting	Screw-in thread M22x1,5
Admissible ambient temperature *	-20...+40 °C
Mounting position	any, preferably horizontal
Fastening torque	$M_D = 50$ Nm for screw-in cartridge
Weight	$m = 1,1$ kg

HYDRAULIC SPECIFICATIONS

Fluid	Mineral oil, other fluid on request
Contamination efficiency	ISO 4406:1999, class 18/16/13 (Required filtration grade $\beta_{6...10} \geq 75$) see data sheet 1.0-50/2
Viscosity range	12 mm ² /s...320 mm ² /s
Admissible fluid temperature *	-20...+40 °C (at inlet and at outlet)
Peak pressure	$p_{max} = 400$ bar $p_{Tmax} = p_p + 20$ bar
Nominal pressure ranges	$p_N = 20$ bar, $p_N = 63$ bar $p_N = 100$ bar, $p_N = 160$ bar $p_N = 200$ bar, $p_N = 250$ bar $p_N = 350$ bar
Volume flow	$Q = 0,3...100$ l/min
Leakage volume flow	see characteristics
Repeatability	$\leq 3\%$ **
Hysteresis	$\leq 4\%$ **
	** at optimal dither signal

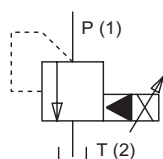
SYMBOL

* Deviating pressure medium - or ambient temperatures are possible for special arrangements after checking and authorisation by a responsible inspector. Measures for the prevention of the exceeding of the admissible solenoid surface - and internal temperatures can be: a good ventilation, low ambient temperatures (for higher pressure medium temperatures), limitation of the maximum possible power supply voltage, a short switching-on duration, installation on large heat dissipating blocks, etc. The responsibility in all cases lies with the operator, resp. with his inspector.

ELECTRICAL SPECIFICATIONS

Construction	Proportional solenoid, wet pin push type, pressure tight
Standard nominal voltage	$U_N = 24$ VDC DC = Ripple 20%; wired with VDR
Limiting current	$I_G = 585$ mA
Relative duty factor	100% DF
Protection class	IP65 / IP67 acc. to EN 60 529
Connection/Power supply	Through cable entry for cable diameter 6...12 mm
Execution T4:	II 2 G EEx em II T4 (for gas) II 2 D IP65 T130°C (for dust)
Performance limit	$P_G = 17$ W

START-UP

1. In the power supply for each solenoid a fuse of an appropriate rating (max. 3 times I_G of solenoid, DIN 41571 or IEC 127) respectively a motor circuit breaker with electromagnetic and thermal interruption must be installed. The fuse may be located in the power supply unit for the solenoid or between power supply and solenoid. The voltage rating for the fuse must be equal or higher than the one for the solenoid.

2. The solenoid coils must only be operated on the valve belonging to them. More information concerning the installation and commissioning is contained in the operating instructions supplied together with the solenoid coil.

CHARACTERISTICS oil viscosity $\nu = 30$ mm²/s

$p = f(Q)$ Pressure volume flow characteristics
(Maximum adjustable pressure)

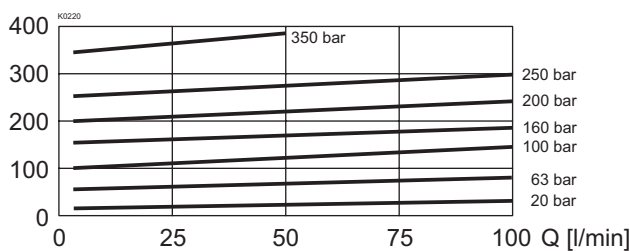

$p = f(Q)$ Pressure volume flow characteristics
(Minimum adjustable pressure)

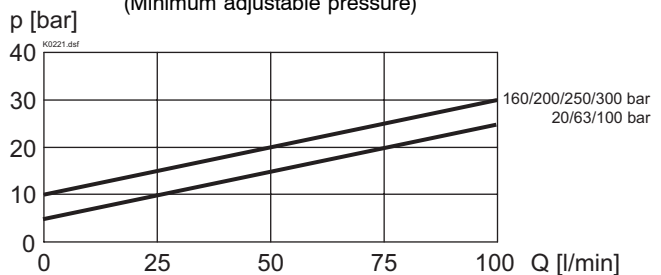

$p = f(I)$ Pressure adjustment characteristics
($Q = 10$ l/min)

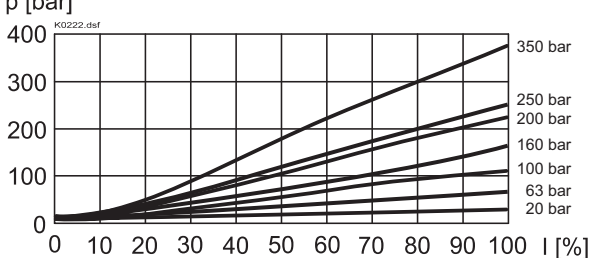

$Q_L = f(p)$ Leakage volume flow characteristics

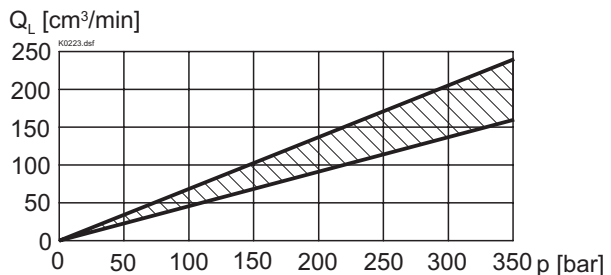
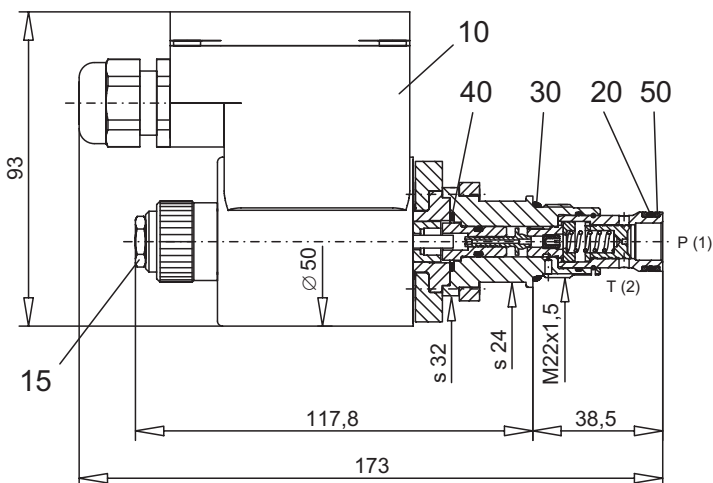
DIMENSIONS / SECTIONAL DRAWINGS

PARTS LISTE

Position	Article	Description
10	207.5286	Slip-on coil 2A52W EExem II T4
15	253.8000	Plug with integrated manual override HB4,5
20	160.2140	O-ring ID 14,00x1,78
30	160.2188	O-ring ID 18,77x1,78
40	049.3177	Back-up ring RD 14,6x17,5x1,4

ACCESSORIES

Cartridge built into flange- or sandwich body

Flange body/sandwich plate

register 2.3

Proportional amplifier

register 1.13

Cavity drawing ISO 7789-22-02-0-98
and cavity tools see

data sheet 2.13-1003

Technical explanation see data sheet 1.0-100E