

**Control cover
for check function**

• $p_{max} = 350 \text{ bar}$

NG 32

ISO 7368
DIN 24342

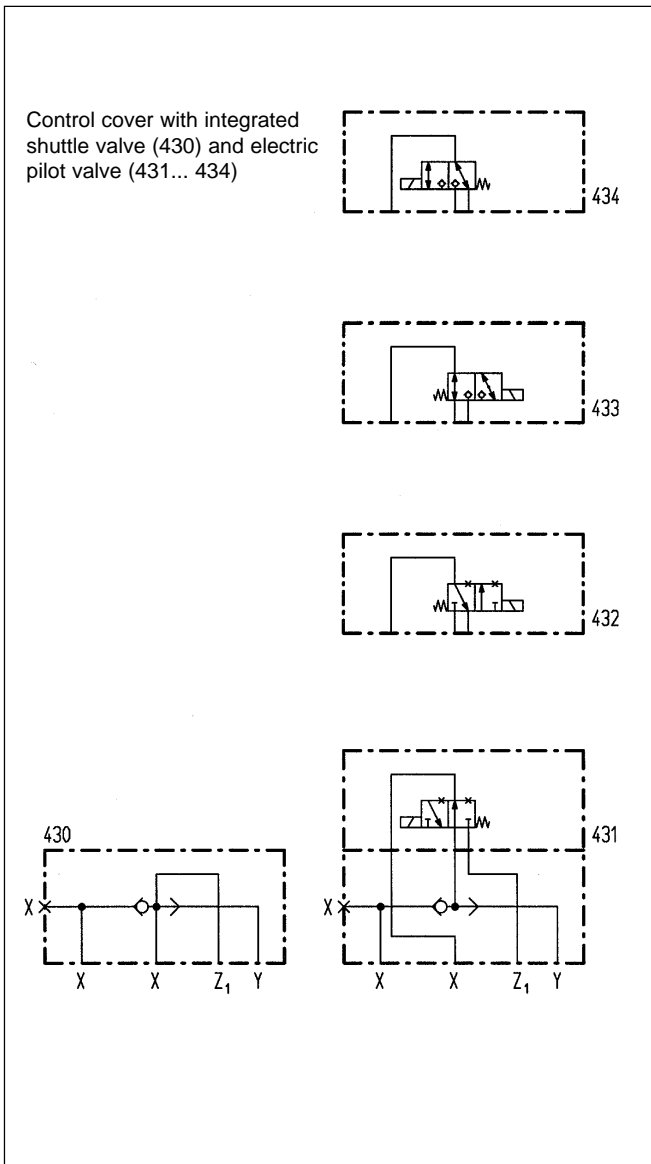
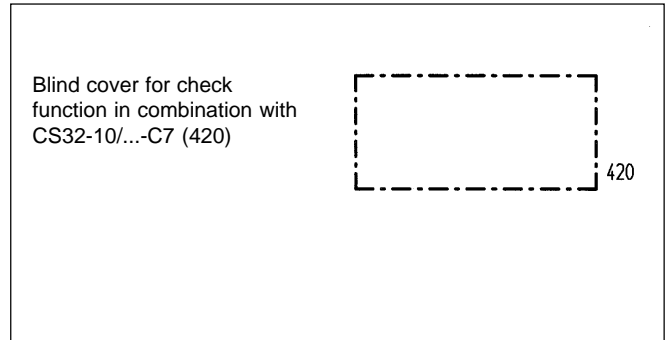
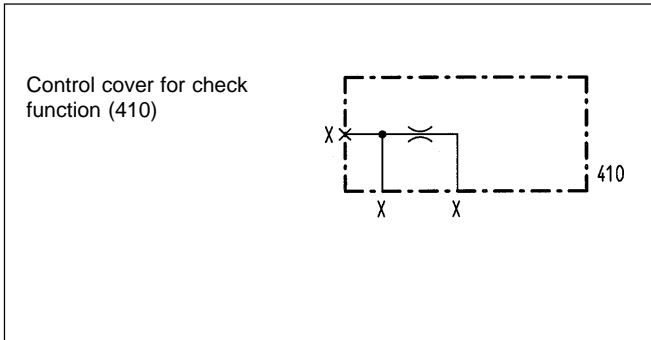

GENERAL SPECIFICATIONS

Construction	Control cover for check function
Mounting position	any
Installation dimension	see dimension to ISO 7368 / DIN 24342 see data sheet 2.13-1023
Ambient temperature	-20...+50°C
Fastening torque	M _D = 190 Nm (qual. 8.8) for fixing screws

HYDRAULIC SPECIFICATIONS

Fluid	Mineral oil, other fluid on request
Contamination efficiency	ISO 4406:1999, class 18/16/13 (Required filtration grade β _{6...10} ≥ 75) see data sheet no. 1.0-50/2
Viscosity range	12 mm ² /s bis 320 mm ² /s
Fluid temperature	-20...+70°C
Operation pressure	p _{max} = 350 bar

TYPE CODE

Control cover	D 32		<input type="checkbox"/>	-	<input type="checkbox"/>	/	<input type="checkbox"/>	#	<input type="checkbox"/>
Nominal size 32									
Pilot no. 410...434									
Solenoid type for pilot valve									
Standard:	431, 432	<input type="checkbox"/>	M						
	433, 434	<input type="checkbox"/>	S						
Standard nominal voltage U _N	12 VDC	<input type="checkbox"/>	G12	110 VAC	<input type="checkbox"/>	R110			
	24 VDC	<input type="checkbox"/>	G24	115 VAC	<input type="checkbox"/>	R115			
				230 VAC	<input type="checkbox"/>	R230			
Orifice in cover:	0.8 mm	<input type="checkbox"/>	0.8						
	1.0 mm	<input type="checkbox"/>	1.0	usw.					
Omit if without orifice									
Design-Index (Subject to change)									

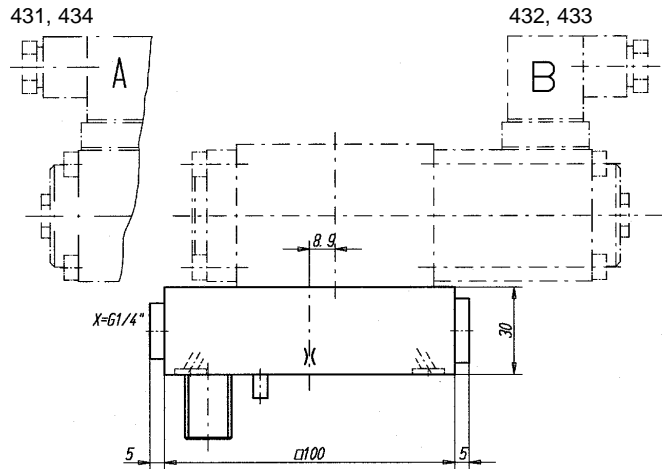
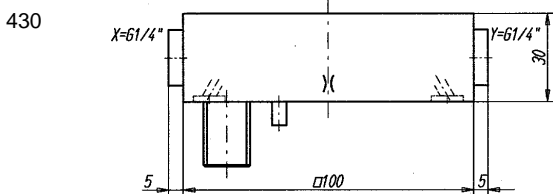
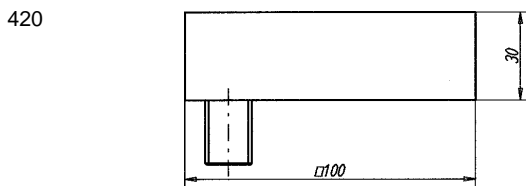
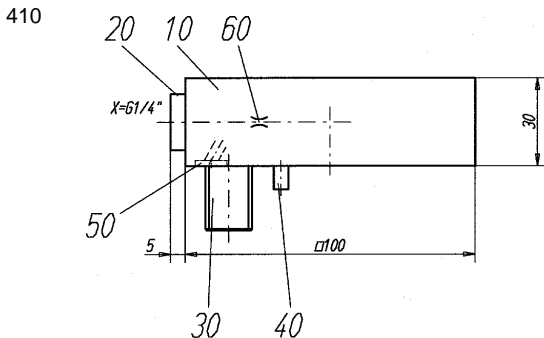
DIMENSIONS

PARTS LIST

Position	Article	Description
10	63.2008	Plate to 410
	63.2000	Plate to 420
	63.2029	Plate to 430
	63.2032	Plate to 431, 432, 433, 434
20	238.2406	Locking screw VSTI G1/4"
	238.3402	Locking screw VSTI G3/8"
30	246.7135	Cyl. screw M16x35 DIN912
40	221.2470	Pin Ø5x16 DIN1481
50	160.2092	O-Ring ID 9,19x2,62
60	118.2010	Orifice M5 / 0,8 x 5
	118.2011	Orifice M5 / 0,9 x 5
	118.2012	Orifice M5 / 1,0 x 5
	118.2020	Orifice M5 / 1,2 x 5
	118.2021	Orifice M5 / 1,5 x 5

VALVES

Pilot operated valves:	431	WDMFA06-AB1	Data sh. 1.2-55
	432	WDMFA06-AB2	Data sh. 1.2-55
	433	AS32060b	Data sh. 1.11-2140
	434	AS32061a	Data sh. 1.11-2140