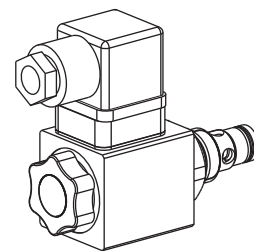

Solenoid poppet valve cartridge
2/2-way version

- Pilot operated
- $Q_{max} = 50 \text{ l/min}$
- $p_{max} = 350 \text{ bar}$

3/4"-16 UNF
 Wandfluh-Norm

DESCRIPTION

Pilot operated 2/2-way poppet valve in screw-in cartridge design with thread 3/4"-16 UNF for cavity according to Wandfluh standard. The valve functions «normally open-CB» and «normally closed-BC» are available. The actuating takes place by means of a solenoid. This can be rotated through 360° and is replaceable without opening the hydraulic system. All components located on the outside are zinc coated and thus protected against rust.

FUNCTION

• «Current-free open -CB»
 In case of a current-free solenoid, it is possible for the flow to pass through the valve in both directions. In case of a solenoid under current, the valve is blocked from connection 2 to 1. If, however, the pressure in connection 1 rises above the solenoid power, the valve opens.

• «Current-free closed -BC»
 In case of a current-free solenoid, the valve is blocked from connection 2 to 1. If, however, the pressure in connection 1 is higher than in connection 2, the valve opens. In case of a solenoid under current, it is possible for the flow to pass through the valve in both directions.

APPLICATION

Wandfluh solenoid operated poppet valves are applied where an absolutely leak free closing of the valve is essential like in load holding, clamping or gripping functions. The solenoid operated screw-in cartridges are mainly used in mobile or stationary integrated blocks.

TYPE CODE

				S V S PU34 -				/ M		35 #	
Poppet valve											
Pilot operated											
Super											
Screw-in cartridge 3/4"-16 UNF											
2/2-way, «normally closed»		<input type="checkbox"/> BC									
2/2-way, «normally open»		<input type="checkbox"/> CB									
Standard-nominal voltage U_N	12 VDC	<input type="checkbox"/> G12	110 VAC	<input type="checkbox"/> R110							
	24 VDC	<input type="checkbox"/> G24	115 VAC	<input type="checkbox"/> R115							
			230 VAC	<input type="checkbox"/> R230							
Slip-on coil made of steel											
Connector	EN 175301-803 / ISO 4400			<input type="checkbox"/> D							
socket:	AMP Junior-Timer			<input type="checkbox"/> J							
	Stranded conductor (length = 500 mm)			<input type="checkbox"/> L							
				} only for execution DC							
Coil type											
Design-Index (Subject to change)											

GENERAL SPECIFICATIONS

Description	Pilot operated 2/2-way solenoid poppet valve
Construction	Screw-in cartridge for cavity acc. to Wandfluh standard
Operation	Solenoid with exchangeable slip-on coil
Mounting	Screw-in thread 3/4"-16 UNF
Ambient temperature	-20...+50 °C 100% DF -20...+70 °C 40% DF/5 min (see characteristics)
Mounting position	any
Fastening torque	$M_D = 30 \text{ Nm}$ for cartridge $M_{D,max} = 5 \text{ Nm}$ for coil retaining nut
Weight	$m = 0,42 \text{ kg}$
Volume flow	see symbols

HYDRAULIC SPECIFICATIONS

Fluid	Mineral oil, other fluid on request
Contamination	ISO 4406:1999, classe 20/18/14 (Required filtration grade $\beta_{10...16} \geq 75$)
Efficiency	see data sheet 1.0-50/2
Viscosity range	12 mm ² /s...320 mm ² /s
Fluid temperature	-20...+70 °C
Working pressure	$p_{max} = 350 \text{ bar}$
Nominal flow	$Q_N = 50 \text{ l/min}$
Pressure drop	see characteristics

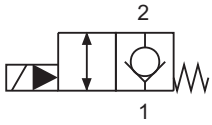
SYMBOLS

SVSPU34-BC...

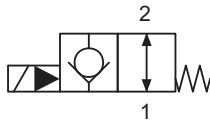

SVSPU34-CB...

ELECTRICAL CONTROL

Construction	Solenoid, wet pin, pull or push type, pressure tight with exchangeable slip-on coil
Standard nominal voltage:	$U_N = 12 \text{ VDC}, 24 \text{ VDC}$ $U_N = 110 \text{ VAC}^*, 115 \text{ VAC}^*, 230 \text{ VAC}^*$ $AC = 50 \text{ up to } 60 \text{ Hz}$
– * Rectifier integrated in connector socket	
– Other nominal voltages and wattages on request	
Voltage tolerance	$\pm 10\%$ of nominal voltage
Protection class	IP 65 acc. to EN 60529 (if correctly mounted)
Relative duty cycle (DF)	100% DF ambient temperature to 50 °C 40% DF ambient temperature to 70 °C (see characteristics)
Operating life	10^7 (number of switching cycles, theoretically)
Connections/Power supply	Versions see type code
Solenoid type:	
- Steel coil (M.35/16x40)	data sheet 1.1-171

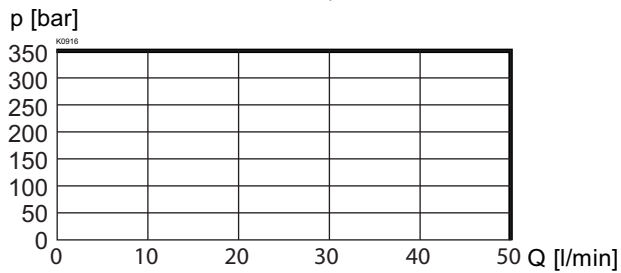
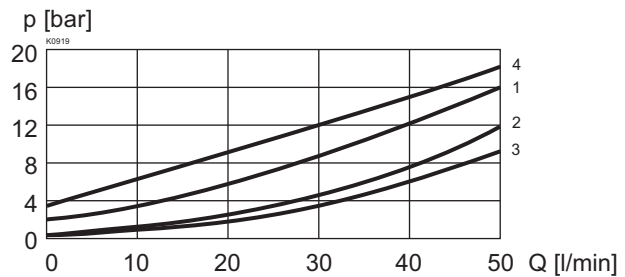
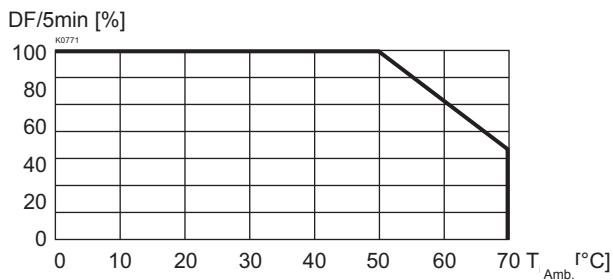
CHARACTERISTICS Oil viscosity $\nu = 30 \text{ mm}^2/\text{s}$
 $p = f(Q)$ Performance limits at 10% under voltage and max. ambient temperature

 $\Delta p = f(Q)$ Pressure volume flow characteristics

 Relative duty factor = f (Ambient temperature)

		BC	CB
Current-free	1 → 2	1	2
Current-free	2 → 1	–	3
under current	1 → 2	2	4
under current	2 → 1	3	–

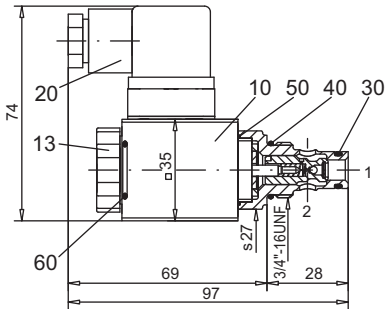
DIMENSIONS/SECTIONAL DRAWING

with DIN connector socket



with Junior-Timer connector socket

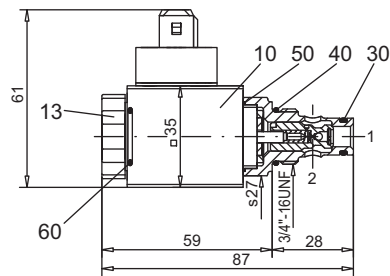

Stranded conductor version

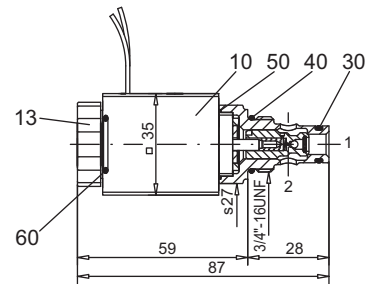

Cavity drawing acc. to Wandfluh standard

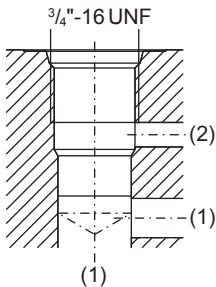

For detailed cavity drawing and cavity tools see data sheet 2.13-1043

PARTS LIST

Position	Article	Description
10	260.4...	Coil complete M.35/16x40
13	154.2600	Knurled nut M16x1x9
20	219.2002	Plug
30	160.0091	O-ring polyurethane ID 9,25x1,78
40	160.2188	O-ring ID 15,60x1,78
50	160.1220	O-ring ID 22,00x1,00
60	160.2156	O-ring ID 15,60x1,78

Technical explanation see data sheet 1.0-100