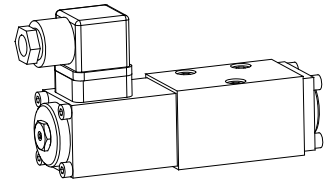

Proportional directional valve

- pressure compensated
- $Q_{max} = 8 \text{ l/min}$
- $p_{max} = 250 \text{ bar}$

NG4-Mini[®]

DISCRIPTION

Directly controlled spool valve, actuated by a Wandfluh proportional solenoid (VDE standard 0580), in five chamber design. Wet solenoid in oil. Spools with precision machined oil passages control the oil volume which is proportional to the solenoid current. Reduced pressure drop achieved by optimised flow channels. Precise spool fit, long life. Spool made of hardened steel, valve body made of high quality cast iron suitable for hydraulic valves. Flange type, threaded connection by means of a connecting plate.

FUNCTION

Spool stroke, aperture and volume flow increase proportionally to the increase in the electric current at the proportional solenoid. This special design senses and compensates load induced flow changes. Flow remains constant with varying pressure. The optimised shape of the spool results in a good resolution of flow important for sensitive motion control. To control the valve Wandfluh proportional amplifiers are available (see register 1.13).

APPLICATION

Because of the high resolution and low hysteresis, these valves are particularly suitable for demanding tasks. Applications: handling operations, robots, actuators, radar controlled vehicles, tool making and paper production machines, in other words anywhere where precise control systems are needed.

CONTENT

GENERAL SPECIFICATIONS.....	1
HYDRAULIC SPECIFICATIONS.....	1
ELECTRICAL SPECIFICATIONS.....	1
TYPE CHARTS/ DESIGNATIONS OF SYMBOLS	2
CHARACTERISTICS.....	2
DIMENSIONS.....	3
PARTS LIST	3
ACCESSORIES.....	3

TYPE CODE

	VWS	4		-		-	TF	-		#	
Proportional control valve											
Number of control ports											
Symbol type see chart on page 2											
Nominal volume flows:											
$Q_N = 2 \text{ l/min}$			02							06	
$Q_N = 4 \text{ l/min}$			04							08	
$Q_N = 6 \text{ l/min}$											
$Q_N = 8 \text{ l/min}$											
Normally closed											
Standard nominal voltage U_N :	12 VDC									G12	
	24 VDC									G24	
Design-Index (Subject to change)											

GENERAL SPECIFICATIONS

Nominal size	NG4-Mini acc. to Wandfluh-standard
Designation	4/2-, 4/3- Proportional control valve
Construction	Direct operated spool valve
Mounting	Flange, 4 holes for socket cap screws M5x40
Fastening torque	$M_D = 5,5 \text{ Nm}$ (screw quality 8.8)
Pipe connection	Connection plates, Multi-station flange subplate, Longitudinal stacking system
Mounting position	any
Ambient temperature	-20...+50 °C
Weight:	4/2-way $m = 1,1 \text{ kg}$ 4/3-way $m = 1,4 \text{ kg}$

ELECTRICAL SPECIFICATIONS

Construction	Proportional solenoid, wet pin push type, pressure tight.	
Standard-Nominal voltage	U = 12 VDC	U = 24 VDC
Limiting current	$I_G = 1250 \text{ mA}$	$I_G = 680 \text{ mA}$
Relative duty factor	100% DF (see data sheet 1.1-430)	
Protection class	IP 65 to EN 60529	
Connection/Power supply	Over device plug connection to ISO 4400/DIN 43650 (2P+E)	
Other electrical specifications	see data sheet 1.1-115 (PI35V)	

HYDRAULIC SPECIFICATIONS

Fluid	Mineral oil, other fluid on request
Contamination efficiency	ISO 4406:1999, class 18/16/13 (Required filtration grade $\beta_{6...10} \geq 75$) refer to data sheet 1.0-50/2
Viscosity range	12 mm ² /s...320 mm ² /s
Fluid temperature	-20...+70 °C
Working pressure	$p_{max} = 250 \text{ bar}$ (ports P, A, B)
Tank pressure	max tank pressure in T $p_{max} = 160 \text{ bar}$
Nominal volume flows	$Q_N = 2 \text{ l/min}$ $Q_N = 6 \text{ l/min}$ $Q_N = 4 \text{ l/min}$ $Q_N = 8 \text{ l/min}$
Min. volume flow	$Q_{min} = 0,020 \text{ l/min}$
Leakage volume flow	on request
Resolution	1 mA *
Repeatability	≤ 1 % *
Hysteresis	≤ 2 % *
	* by optimal dithersignal

TYPE CHARTS/DESIGNATIONS OF SYMBOLS

	D41
	Z41a
	Z41b
	D42
	Z42a
	Z42b

CHARACTERISTICS oil viscosity $\nu = 30 \text{ mm}^2/\text{s}$

$Q = f(p)$ Volume flow-pressure-characteristics

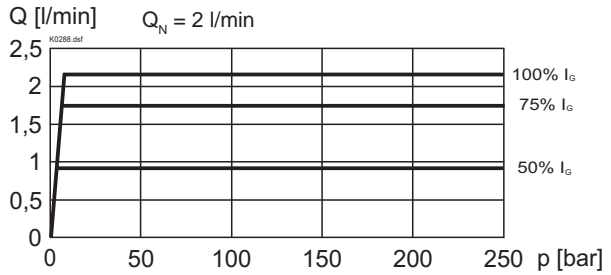

$Q = f(p)$ Volume flow-pressure-characteristics

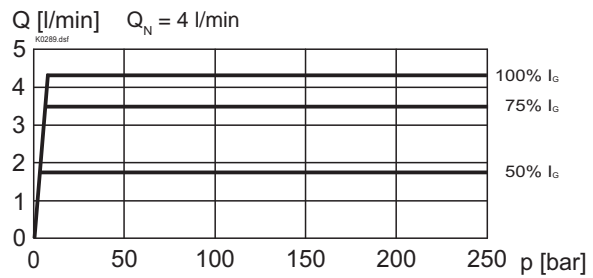

$Q = f(p)$ Volume flow-pressure-characteristics

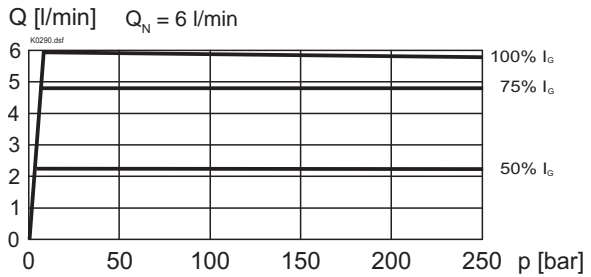

$Q = f(p)$ Volume flow-pressure-characteristics

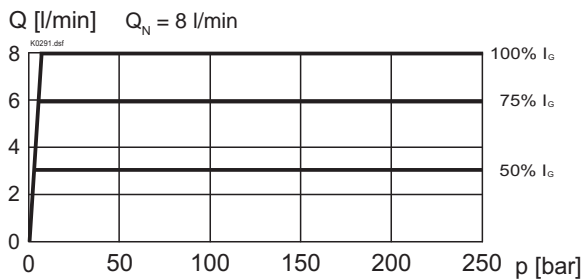

$Q = f(I)$ Volume flow-signal-characteristics

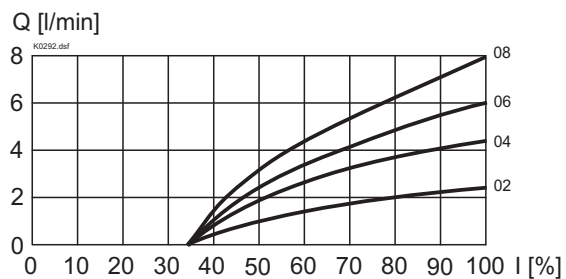

DIMENSIONS

4/3-way valve

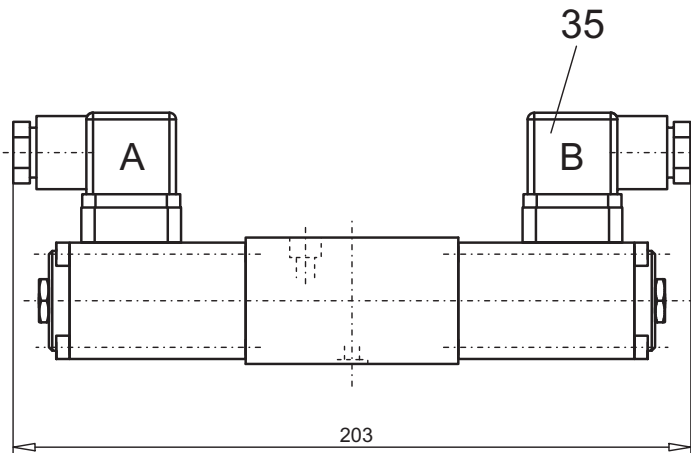

4/2-way valve

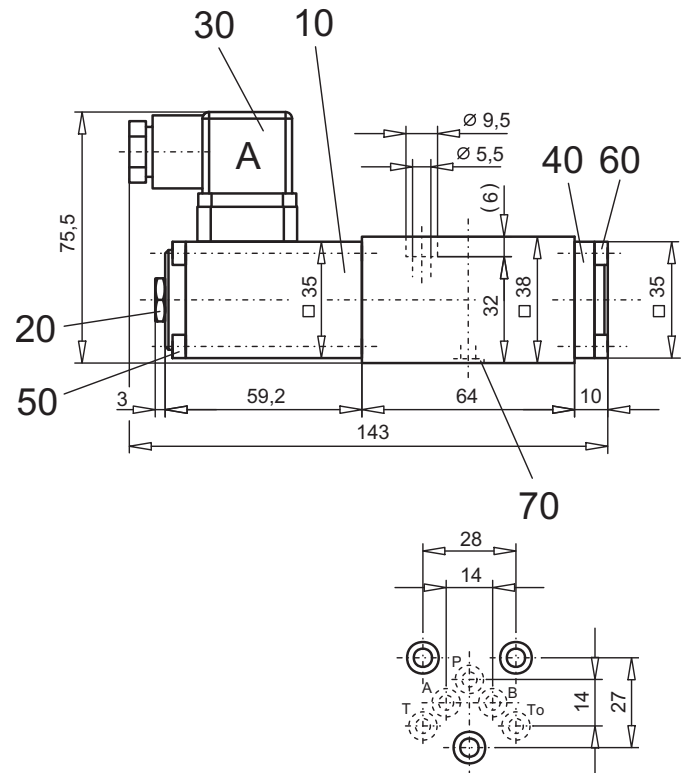
PARTS LIST

Position	Article	Description
10	256.3454 256.3426	Proportional solenoid PI35V-G24 Proportional solenoid PI35V-G12
20	253.8000	Plug with integrated manual override HB4,5
30	219.2001	Plug A (grey)
35	219.2002	Plug B (black)
40	057.4208	Cover
50	246.1161	Socket head cap screw M4 x 60 DIN 912
60	246.1111	Socket head cap screw M4 x 10 DIN 912
70	160.2052	O-ring ID 5,28 x 1,78

ACCESSORIES

Sub-plates	register 2.9
Proportional-amplifier	register 1.13

Technical explanation see data sheet 1.0-100