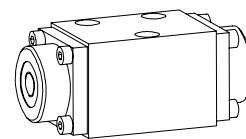

Spool valve hydraulic operation

- 4/2-way impuls valve
- 4/3-way with spring centered mid position
- 4/2-way with spring reset
- $Q_{max} = 20 \text{ l/min}$, $p_{max} = 315 \text{ bar}$

NG4-Mini[®]

DESCRIPTION

Spool valve NG4-Mini, flange type in accordance to Wandfluh standard with 4 connections. Direct hydraulic operation via pilot ports in end covers. 5 chamber system. Spool with spring return or detented. Precise spool fit, low leak, long life. Threaded ports by means of additional connecting plate. Hardened spool. Valve body made of high quality casting. Valve body painted, end covers phosphated.

FUNCTION

Pilot pressure shifts spool to end position.

- 4/2-way impulse
2 pilot ports. 2 detented spool positions. Spool held in position by detent unless opposite pilot port is pressurised to shift back.
- 4/3-way spring centered
2 pilot ports. 3 spool positions. Spool shifted to center position by spring as pilot pressure decays.
- 4/2-way spring offset
1 pilot port. 1 drain port on spring side, 2 spool positions. Spool shifted to home position by spring as pilot pressure decays.

APPLICATION

Hydraulically operated spool valves are mainly used to control the direction of movement and retain hydraulic cylinders and motors. The direction of movement is determined by the position of the valve spool and its symbol. Hydraulically operated valves are particularly suitable for use in installations where no electric current is available or for applications in areas with a risk of explosion (chemical industry, tunnel construction). Mini-4 valves are used where both, reduced dimensions and weight are important.

CONTENT

GENERAL SPECIFICATIONS	1
HYDRAULIC SPECIFICATIONS	1
CONTROL HYDRAULIC	1
TYPE CHARTS/SYMBOLS	2
CHARACTERISTICS	2
DIMENSIONS	3
PARTS LIST	3
ACCESSORIES	3

TYPE CODE

	B	P	4		#	
Interface						
Hydraulic operation						
No. of control ports						
Type charts/Symbols acc. to table 1.7-20/2						
Design-Index (Subject to change)						

GENERAL SPECIFICATIONS

Description	4/2-, 4/3-way spool valve
Nominal size	NG4-Mini to Wandfluh standard
Construction	Direct operated spool valve
Operations	Hydraulic
Mounting	Flange
	3 fixing holes for socket head cap screws M5x40
Connections	Threaded connection plates Multi-flange plates Longitudinal stacking system
Ambient temperature	-20...50°C
Mounting position	any, preferably horizontal
Fastening torque	$M_D = 5,5 \text{ Nm}$ (screw quality 8.8)
Weight	$m = 0,6 \text{ kg}$

HYDRAULIC SPECIFICATIONS

Fluid	Mineral oil, other fluid on request
Contamination efficiency	ISO 4406:1999, class 20/18/14 (Required filtration grade $\beta_{10...16} \geq 75$) refer to data sheet 1.0-50/2
Viscosity range	12 mm ² /s...320 mm ² /s
Fluid temperature	-20...+70°C
Operating pressure in port P, A, B	$p_{max} = 315 \text{ bar}$
Tank pressure in port T	$p_{max} = 90 \text{ bar}$ resp. 10 bar below p_{st}
Max. Volume flow	$Q_{max} = 20 \text{ l/min}$, see characteristics
Leakage volume flow	see characteristics

CONTROL HYDRAULIC

Min. pilot pressure	$p_{st \text{ min}} = 10 \text{ bar}$
Max. pilot pressure	$p_{st \text{ max}} = 100 \text{ bar}$
Control volume	$V_{st} = 0,16 \text{ cm}^3$

TYPE LIST / DESIGNATION OF SYMBOLS

4/2-way valve impulse

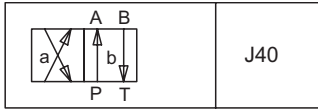

J40

4/2-way valve with spring reset

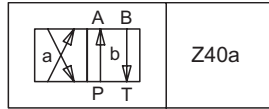

Z40a

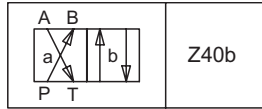

Z40b

Transitional functions

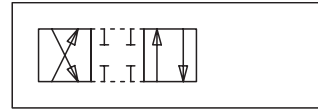

4/3-way valve spring centered or detented

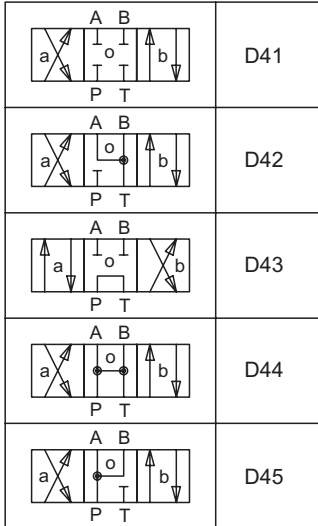

D41

D42

D43

D44

D45

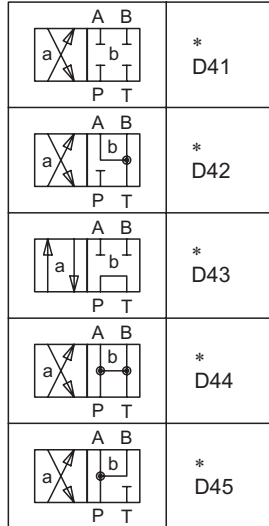

* D41

* D42

* D43

* D44

* D45

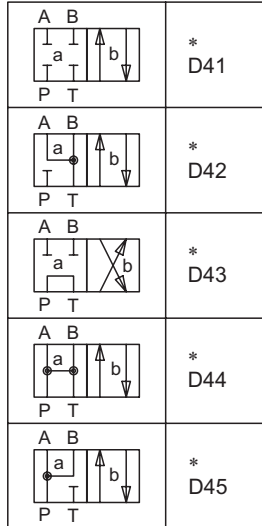

* D41

* D42

* D43

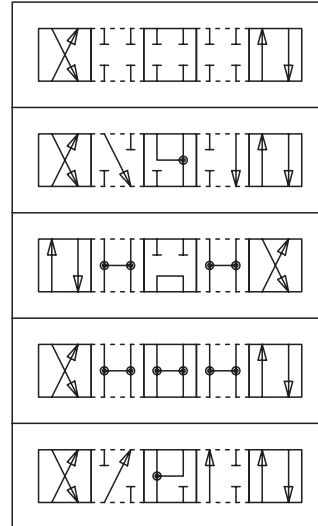

* D44

* D45

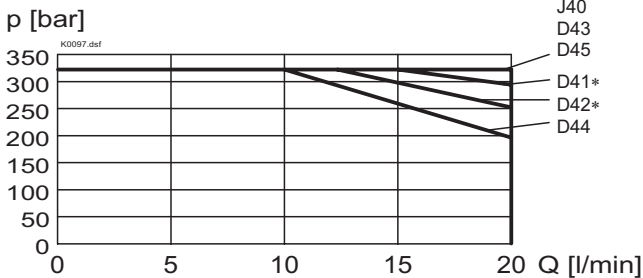
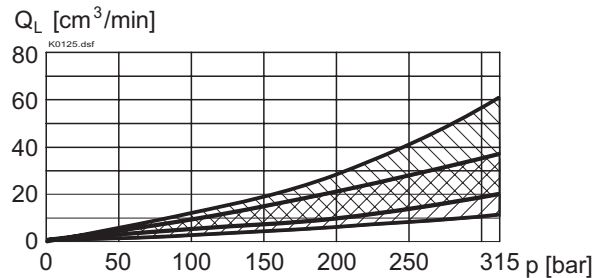

On all 4/2-way valves with spring reset the spring side must be connect to a tank or drain line.

* The 4/2-way valves with spring reset are being delivered as 4/3-way valves.

CHARACTERISTICS Oilviscosity $\nu = 30 \text{ mm}^2/\text{s}$
 $p = f(Q)$ Performance limits

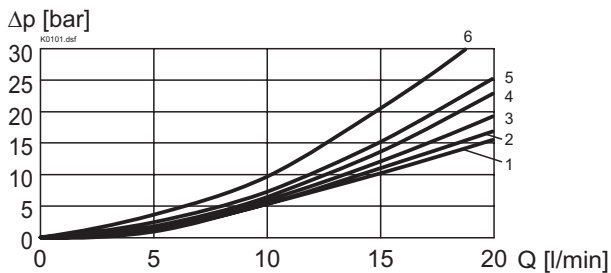
 * Performance limit with $p_v = 12 \text{ bar}$; $Q = 20 \text{ l/min}$ and 315 bar
 $Q_L = f(p)$ Leakage volume flow characteristics per control edge

 Leakage envelope J40/Z40/D41/D42/D44/D45
 Leakage envelope D43

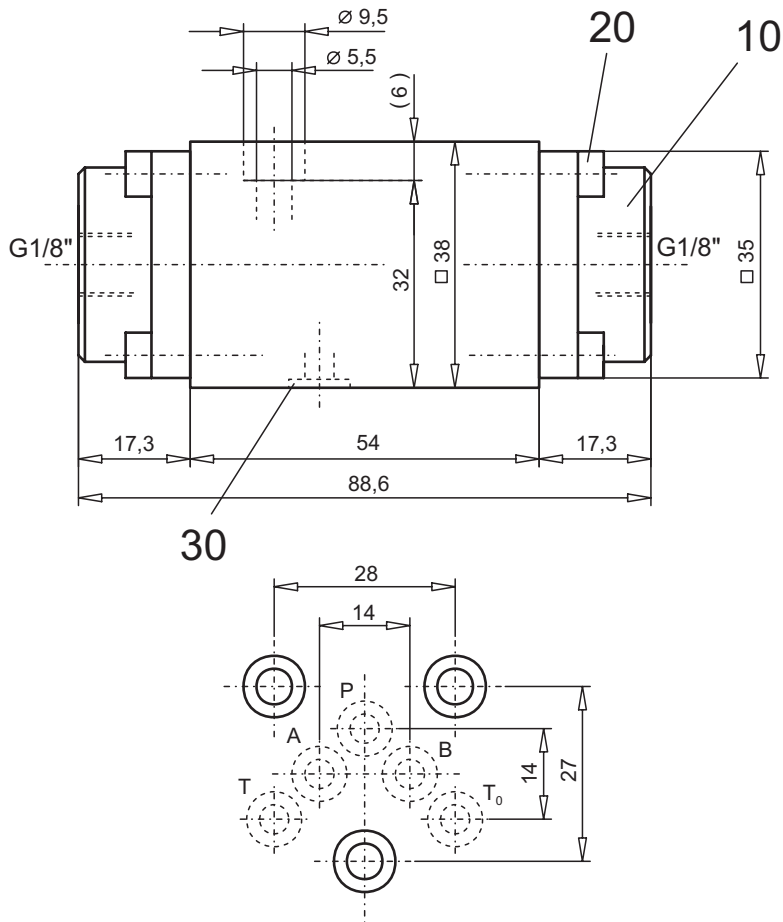
 $\Delta p = f(Q)$ Pressure drop volume flow characteristics

Symbol	Volume flow direction				
	P - A	P - B	P - T	A - T	B - T
Z40/J40	5	5	-	2	2
D41	5	5	-	2	2
D42	5	5	-	1	1
D43	4	4	6	2	2
D44	4	4	3	2	2
D45	4	4	-	2	2

DIMENSIONS

PARTS LIST

Position	Article	Description
10	057.4600	Cover
20	246.1112	Socket head cap screw M5x12 DIN 912
30	160.2052	O-ring ID 5,28x1,78

ACCESSORIES

Threaded connection plates, Multi-flange plates and longitudinal stacking system

register 2.9

Technical explanation see data sheet 1.0-100E